



LEAPERS[®]

THE BEST NEVER REST

2024



TABLE OF CONTENTS

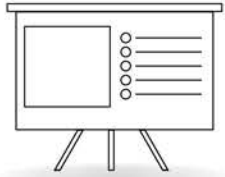

COMPANY INTRODUCTION 004
 WE ARE FAMILY 004
 THE LEAPERS JOURNEY 006
 NETWORK & BENEFITS 008
 WHAT'S NEW 010

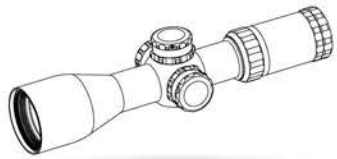

SCOPES 012
 INTEGRIX SCOPES **[NEW]** 014
 iX8 LPVO / 1-8X28 FFP 021
 iX6 MID POWER / 2-12X36 FFP 023
 iX6 MID POWER / 3-18X44 FFP 025
 iX6 LR/ELR / 4.5-27X56 FFP 027
 iX8 LPVO / 1-8X28 SFP 029
 ACCUSHOT PRO SCOPES **[NEW]** 030
 AS6 LPVO / 1-6X24 FFP 035
 AS3 MID POWER / 3-9X36 FFP 037
 AS6 LPVO / 1-6X24 SFP 039
 UTG SFP SCOPES 040
 SCP3 SCOPES 045
 OP3 SCOPES 047
 BUG BUSTER SCOPES 049
 TRUE HUNTER SCOPES 051
 CROSSBOW SCOPES 053
 LONG EYE RELIEF SCOPES 055
 RETICLES 056
 SCOPE SPECIFICATIONS 060

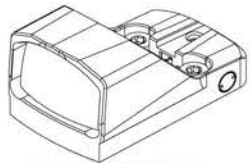

DOT SIGHTS & MAGNIFIERS 062
 UTG ACCU-SYNC DOT SIGHTS **[NEW]** 064
 DS2521R FOR MINI ACOG FOOTPRINT 065
 DS2018R FOR MINI ACOG FOOTPRINT 065
 UTG OP3 MICRO MRDS 066
 MINI MRDS FOR SHIELD RMSC FOOTPRINT 066
 MRDS/SL/SLS FOR DOCTER FOOTPRINT 067
 MRDS/SLS FOR RMR FOOTPRINT 067
 UTG 3X FLIP-TO-SIDE MAGNIFIER 068
 UTG ITA DOT SIGHTS 068

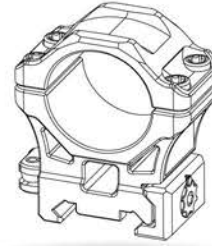

OPTIC MOUNTS & RINGS 071
 ACCU-SYNC QR CANTILEVER MOUNTS **[NEW]** 073
 ACCU-SYNC QR SCOPE RINGS 075
 ACCU-SYNC CANTILEVER RINGS & MOUNTS 077
 ACCU-SYNC ANTI-CANT LEVELERS 077
 UTG PRO P.O.I SCOPE RINGS 079
 UTG SCOPE RINGS & MOUNTS 081
 DOVETAIL-TO-PICATINNY MOUNTS 082
 DRILLED & TAPPED RECEIVER MOUNTS 083
 SHOTGUN SIDE SADDLE MOUNTS 083
 AK & M1A RECEIVER MOUNTS 084
 PICATINNY RISERS 085
 DEDICATED OPTIC MOUNTS 086
 PICATINNY MOUNTS FOR DOCTER/RMR 086
 PICATINNY MOUNTS FOR AIMPOINT MICRO 086
 DOVETAIL MOUNTS FOR RMR 087
 DOVETAIL MOUNTS FOR DOCTER 087

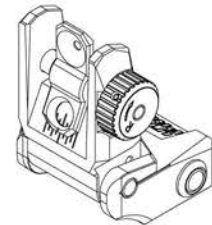

IRON SIGHTS 088
 UTG PRO FLIP-UP SIGHTS 091
 UTG ACCU-SYNC 45° FLIP-UP SIGHTS 092
 UTG SUPER SLIM FLIP-UP SIGHTS 093
 UTG ACCU-SYNC FLIP-UP SIGHTS 093
 AR FIXED SIGHTS 094
 CARRY HANDLES 094
 SUPER SLIM FIXED SIGHTS 095

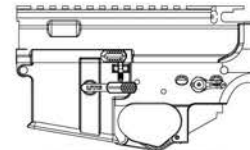

RECEIVERS 097
 UTG PRO AMBI BILLET RECEIVERS **[NEW]** 098
 UTG PRO BILLET RECEIVERS **[NEW]** 103

HANDGUARDS 104
 MP5 MONOLITHIC HANDGUARD **[NEW]** 107
 FORERUNNER FREE FLOAT 109
 ARWEN FREE FLOAT 111

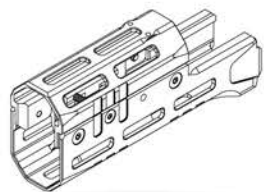

SUPER SLIM SD FREE FLOAT113
 ULTRA SLIM FREE FLOAT.....115
 SUPER SLIM FREE FLOAT115
 DROP-IN HANDGUARDS116
 AR15 DROP-IN117
 AK DROP-IN.....118
 RUGER PC CARBINE DROP-IN.....119

BIPODS



RECON 360 TL BIPODS122
 UTG PRO TBNR BIPODS.....125
 BIG BORE FULL STABILITY BIPOD127
 OVER BORE BIPOD129
 RECON FLEX BIPODS131
 D GRIP.....132
 QUICK DETACH BIPODS.....133

STOCKS, BUFFERS & TUBES

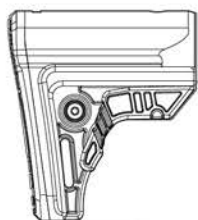

AK SIDE FOLDER **[NEW]**136
 AR COLLAPSIBLE STOCKS.....138
 AR15 FIXED STOCKS.....140
 AR308 FIXED STOCK.....140
 TUBES & BUFFERS142

GRIPS & HAND STOPS

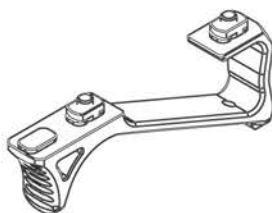

PISTOL GRIPS146
 VERTICAL GRIPS147
 ULTRA SLIM ANGLED FOREGRIPS.....148
 HAND STOPS149

MAGAZINES

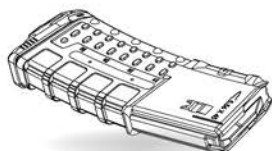

AK/AKM POLYMER MAGAZINE **[NEW]**152
 AR POLYMER MAGAZINES **[NEW]**154
 POLYMER MAGAZINES FOR GLOCK.....156



FLASHLIGHTS & LASERS

FLASHLIGHTS & LASERS158
 LASERS160
 FLASHLIGHT & LASER ACCESSORIES.....161
 WEAPON LIGHTS.....162
 2-IN-1 LASER/FLASHLIGHT COMBOS163

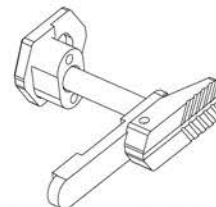

ACCESSORIES & TOOLS

M-LOK ARCA RAILS **[NEW]**166
 RAIL SECTIONS & COVERS168
 QD SLING SWIVELS & ADAPTORS.....169
 AR ACCESSORIES170
 MUZZLE DEVICES & GAS BLOCKS171
 CZ SCORPION ACCESSORIES172
 TOOLS & MAINTENANCE173



GUN CASES

RAPID DEPLOYMENT PACKS174
 RC CASE178
 MC CASE180
 KIS KEEP-IT-SIMPLE CASE182
 PISTOL CASES.....184



TACTICAL GEAR

TRAIL SEEKER, TRAIL CAM BACKPACK.....188
 OVERBOUND PACK190
 ALL-IN-ONE RANGE/UTILITY GO BAG192
 HOLSTERS **[NEW]**194
 LONG GUN SLINGS & BELT196
 TACTICAL VESTS197

Third party trademarks may be used in this catalog for the convenience of customers to indicate the fit or compatibility of the applicable Leapers items.



AT LEAPERS, WE ARE FAMILY

At Leapers, we are family. Our employees and our customers are family, united by our passion for shooting, hunting, and the right to bear arms.

Our mission is to be the one stop shop for all your firearm accessory needs, making accessories more accessible to all those who share the same passion.

We started our journey 31 years ago in Michigan USA. We sold our first 4x28 scope out of our garage and drove my Ford F150 hundreds of miles over state lines to take care of our customers. Today we have over 280 employees and 1,900 customers worldwide. No matter how big we grow, or the size of the customer, we consider each of you family. This year marks a true milestone with the launch of our new INTEGRIX line of premium scopes and our Made in USA billet AR receivers, to include our true ambidextrous lower.

Welcome to the Leapers family. We look forward to hearing what you think – and growing together.

Hand Drawn

INTEGRIX™

ACCUSHOT PRO™

UTG®
PRO
MADE IN USA

UTG®



OUR JOURNEY

Leapers was founded in 1992. Over the past 3 decades we have relentlessly invested in our in-house capabilities as our commitment to being your #1 solution provider.

In 2009 we built our USA Manufacturing plant, which now has over 40 Aerospace CNC machines across Mazak, Mori Seiki, Miyano, and Brother brands. We established our European distribution center in Frankfurt, Germany in 2012 and opened our R&D center in Taiwan's world class semiconductor manufacturing neighborhood in 2018.

Over the past 2 years we have doubled down on testing and validation, building a 100-yard indoor shooting range and testing facility here at our headquarters. We are proud to own our process end-to-end, from concept to delivery.



LEND US YOUR VOICE AND HELP US IMPROVE.

Over the past year we have challenged ourselves to catch customers in the wild and get closer to your needs from using expert focus groups, influencer relationships, to competing alongside you in events. Stop by at upcoming competitions and shows in 2024 or give us a call to chat with a service rep. Learning from you makes our products better and allows us to be your #1 solution provider.

SEE THE DIFFERENCE WITH INTEGRIX.

This year we are proud to release our new top-of-the-line INTEGRIX optics, leading with our 1-8X28 LPVO. We took the time to perfect every detail, from optics design and industry-leading glass to durable mechanics and tactile feedback. INTEGRIX cuts through the haze and near darkness to deliver a clear wide field of view. Pick one up; you must see it to believe it.



TRY OUR NEW TRUE AMBI AR RECEIVER.

Our new Made-in-the-USA billet receivers address all your pain points when it comes to ergonomics, manipulation, and more no matter how big or small the point is. We built a true ambidextrous receiver with right-side bolt catch and release. Buffer and rear takedown pin detents and springs stay captured within the receiver instead of disappearing into the void. Diligence shows throughout, from our purpose-driven design, precision manufacturing, to the shots you place on target downrange.



OUR NETWORK

522
PRODUCTS

1938
WHOLESALE

71
COUNTRIES

DEALER BENEFITS

-  Accommodating Minimum Order Value (MOV)
-  300 Minimum Order Quantity (MOQ)
-  Same or Next Day Shipping
-  Flexible Fulfillment Worldwide
-  Personally Assigned Sales Representative
-  Dedicated Customer Service in USA
-  Opt-in to Product Notifications Today
-  Monthly & Seasonal Promotions



HEADQUARTERS
MICHIGAN, USA



Leapers is a global business headquartered in Livonia, Michigan, USA. Our 150,000 square foot, 4-building campus is home to the entire lifecycle, from product design and manufacturing to an indoor shooting range and testing facility. Our sales, marketing, and customer service teams sit right next to fulfillment and distribution for streamlined efficiency.



M&L PROGRAM

Military and Law Enforcement Program: Access special retail discounts if you are active military, veteran military, or law enforcement looking to buy. We thank you for your service. Apply directly through our website today.



**SCAN TO CHECK OUT MORE
ABOUT MILITARY & LAW
ENFORCEMENT**

FIND A STORE

We distribute to over 1,900 wholesalers worldwide, from local brick and mortar to ecommerce sites. Check out our website to learn where you can buy our products and find a dealer near you.



**SCAN TO FIND OUT THE
NEAREST DEALER FROM
YOUR LOCATION**



**EU DISTRIBUTION
CENTER
ORTENBERG, GERMANY**

**R&D
& MANUFACTURING
CENTER
NANTONG, PRC**

**R&D
& MANUFACTURING
CENTER
MIAOLI, TAIWAN**

WHAT'S NEW



P106

UTG PRO UTG PRO MP5 MONOLITHIC M-LOK HANDGUARD



P014



INTEGRIX SCOPE LINE: 1-8X28 FFP & SFP LPVO, 3-18X44 FFP MID RANGE, 4.5-27X56 FFP LONG RANGE

INTEGRIX



P098

UTG PRO UTG PRO AR15 BILLET RECEIVER UPPER LOWER WITH TRUE AMBI



P136

UTG PRO UTG PRO AK SIDE FOLDER STOCK, FOR ZASTAVA YUGO



INTRODUCTION



UTG AK/AKM WINDOWED POLYMER MAGAZINE,
7.62X39MM, 30 ROUND



ACCU-SYNC 2016R DOT SIGHT
FOR MINI ACOG FOOTPRINT



UTG PRO M-LOK ARCA RAILS

LEAPERS WHAT'S NEW 2024



ACCUSHOT PRO SCOPE LINE: 1-6X24 FFP & SFP LPVO,
3-9X36 FFP MID RANGE



ACCU-SYNC QR CANTILEVER
MOUNTS WITH MOA
COMPENSATION



UTG CONCEALED BELT HOLSTER
WITH METAL CLIP, RIGHT HANDED

SCOPES



A NEW TRAJECTORY TOWARDS AUGMENTED ACCURACY.

Shooter Driven Feedback. The core principle of INTEGRIX™ and ACCUSHOT PRO™, our two latest brands of optics for 2024. For over 30 years, our optics have outfitted shooters of all disciplines and experiences. Continuing this legacy are a host of new models with more reticle options, improved glass, and greater accessibility. Send it downrange and make your mark with an INTEGRIX™, ACCUSHOT PRO™ or UTG® scope.



JUMP TO A SERIES

INTEGRIX™ SCOPES [NEW]

iX8 LPVO / 1-8X28 FFP	014
iX6 Mid Power / 2-12X36 FFP	021
iX6 Mid Power / 3-18X44 FFP	023
iX6 LR/ELR / 4.5-27X56 FFP	025
iX8 LPVO / 1-8X28 SFP	027
	029

ACCUSHOT PRO™ SCOPES [NEW]

AS6 LPVO / 1-6X24 FFP	030
AS3 Mid Power / 3-9X36 FFP	035
AS6 LPVO / 1-6X24 SFP	037
	039

UTG® SFP SCOPES

SCP3 Scopes	040
OP3 Scopes	045
BUG BUSTER® Scopes	047
TRUE HUNTER® Scopes	049
Crossbow Scopes	051
Long Eye Relief Scopes	055

RETICLES

SCOPE SPECIFICATIONS

	056
	060

[THIRD PARTY TRADEMARKS MAY BE USED IN THIS CATALOG FOR USER CONVENIENCE TO INDICATE THE FIT OR COMPATIBILITY OF THE APPLICABLE PRODUCT.]



CHALLENGING WHAT'S STANDARD.





INTEGRIX™

A critical decision made often by shooters is what optic to pick for their firearms. It is a decision, one of integrity and intelligence to justify what we consider to be quality.

The voice of the customer has spoken. Leapers has listened, and listened with decades of attention as well as persistent R&D. We have learned that quality optics achieve optimal performance only when superior optical design and mechanical precision integrate seamlessly under the strictest tolerance control. When such standards are met at the manufacturing level, our customers' dreams come true.

LEAPERS brings to the forefront of shooters, the culmination of integrated and intelligent optical design and manufacturing. **THIS IS INTEGRIX™.**



**SUPERIOR QUALITY.
RUGGED PERFORMANCE.
VIVID DETAIL.
THIS IS INTEGRIX™.**

INTEGRIX™

SUPERIOR OPTICAL SYSTEM

THE CULMINATION OF INTEGRATED & INTELLIGENT OPTICAL DESIGN & MANUFACTURING.

INTEGRIX™ optics adhere to the highest of manufacturing and optical standards demanded by distinguished shooters. From the sum of its parts and throughout its assembly, INTEGRIX™ encompasses the attention to detail needed to achieve consistent and repeatable precision shot-to-shot. Finish with top-performing results downrange with an optic that is built ready for when and where it counts. The solution is you. The difference is INTEGRIX™.

THE END RESULT?

An optical system that gathers, converges, and optimizes incoming light while eliminating all non-contributing stray light known to degrade image contrast and resolution.

VIVID VISUALS

92% light transmission that vividly and positively identifies even the smallest of details from the environment and your target.



Advanced 92% Light Transmission Excels Both During the Day and in Low Light Environments



Superior Field of View (FOV)



Low Aberration Industry-leading Glass



Maximum Edge-to-Edge Clarity



HIGH DEFINITION

All lenses are individually centration tested prior to assembly and are then concentric tested as a whole system post assembly ensuring lens arrangement meets INTEGRIX™ TDP specification.



INDUSTRY-LEADING GLASS.

German SCHOTT and Japanese OHARA glass, the leaders in craftsmanship and high-definition image quality.

EXACTING STANDARDS

Systematic optical pathway precisely guides the archaic nature light refraction takes through the scope ensuring its pathway is uninterrupted and optimized for the focal plane of the scope.



Optimized Color Contrast with Reduced Chromatic Aberration



Vivid Detail and HD Visual Quality

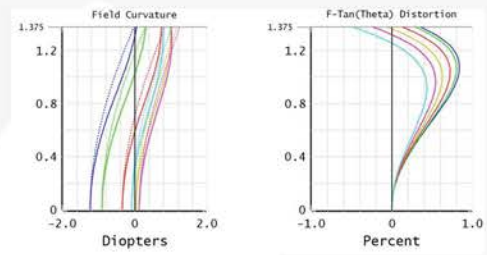

Distortion, Field Curvature & Astigmatism Analyzing & Optimization

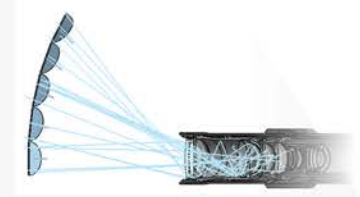

Stray Light Optical Design Analysis

INTEGRIX™

READY FOR WHEN & WHERE IT COUNTS

CONSTANT EYE RELIEF

Maintains a Constant, but Generous Eye Relief Throughout the Entire Magnification Range.

SMOOTH TURN POWER RING

Accurately and Securely Transitions Without a Hitch with Just the Right Amount of Feedback.

Optional Extended Throw Lever Included.

WIDE DIOPTRER ADJUSTMENT

Caters to More Variations in Eyesight and Finely Tunes Reticle Clarity to the User's Unique Vision.

DIGITAL ILLUMINATION & SIDE PARALLAX TURRET

Intuitive Interface with Automatic 12 Hour Shutoff Effortlessly Toggles Between Red and Green Illumination Settings (Excludes Fixed Parallax Models with Analog Interface).

Precise Parallax Adjustment Scales with Just the Right Amount of Resistance and Feedback (Excludes Fixed Parallax Models).

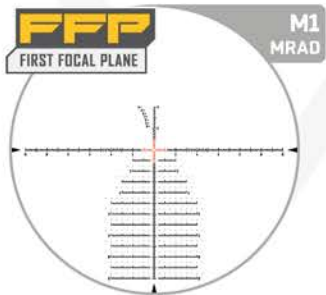



■ PRECISE MOVEMENT WINDAGE & ELEVATION TURRETS

Push/Pull Lockable and Zero Resettable Uncapped Turrets Serrated and Oversized for Gloved Use.

Includes Zero Stop Function (High Power and Some Mid Power Models Only).

Reliable and Precise Steel-on-Steel Movement with Predictable, Tactile, and Audible Click Values.



INTEGRIX™

FIND WHAT'S RIGHT FOR YOU

VIVID VISUALS.

INTEGRIX™ optics are designed to maximize and transmit to the shooter's eye what present and available light there is in the environment.

Lenses within INTEGRIX™ optics are coated in a way that prioritizes blue light transmittance which provides a discerning advantage in twilight or near dark conditions.

INDUSTRY-LEADING GLASS.

German SCHOTT and Japanese DHARA, known for producing glass with very low striae content, which if not mitigated, introduces aberration within the optical system. In other words, shooters will not be limited by their glass when choosing INTEGRIX™.

HIGH DEFINITION.

The systematic optical pathway in every INTEGRIX™ optic precisely guides the archaic nature light refraction takes through the scope ensuring its pathway is uninterrupted and optimized for the focal plane of the scope.

The spacers used to position each lens within an INTEGRIX™ optic are each held to exacting standards. The extremely tight tolerances that are met guarantees the correct positioning of the lenses for the scope's optimized focal point requirement.



1-8x28 / A1 MOA Reticle / FFP (pg.021)
1-8x28 / A3 BDC Reticle / SFP (pg.029)



2-12x36 / A2 MOA Reticle / FFP (pg.023)
3-18x44 / A2 MOA Reticle / FFP (pg.025)
3-18x44 / M1 MRAD Reticle / FFP (pg.025)



4.5-27x56 / M1 MRAD Reticle / FFP (pg.027)
4.5-27x56 / M2 MRAD Reticle / FFP (pg.027)

INTEGRIX™



LOW POWER [LPVO]

A popular choice for the AR15 platform and other similar carbines that see a variety of dynamic and on-the-move close to medium range engagements. With its variable magnification starting at 1x and ending at higher magnifications typically under 10x, LPVOs excel in versatility and are often considered to be a great general-purpose solution.





1-8X28 FFP SCOPE / LPVO

LOW
POWER

FFP
FIRST FOCAL PLANE



INTEGRIX™

ix8 1-8X28 FFP / 34MM / LPVO **NEW**

- » Individually Centration Tested German and Japanese Glass Lenses, Concentric Tested Post Assembly
- » Multi-coated Lenses for Glare, Reflection, and Scratch Resistance
- » Low Aberration Optimized Image Quality with Over a 92% Light Transmission
- » Edge to Edge Sharpness, High Contrast, and High-resolution Standard
- » Reliable Adverse Temperature and Environmental Performance with -40° to 160° Fahrenheit Operational Range and IPX7 Waterproof Rating
- » Rated, at Minimum, for .338 LAPUA Magnum
- » Red and Green Reticle Illumination with 10 Brightness Intensity Settings
- » 12 Hour Automatic Shutoff
- » Intuitive Lockable and Zero Resettable Windage and Elevation Turrets, Serrated and Oversized for Glove Use
- » Serrated Power Ring and Rear Adjustable Eyepiece Diopter
- » Make Transitioning Across Magnification Range Effortless with Included Oversized Throw Lever

ETCHED GLASS RANGE-ESTIMATING A1 MOA RETICLE

(* Refer to P. 056-059 for More Info.)

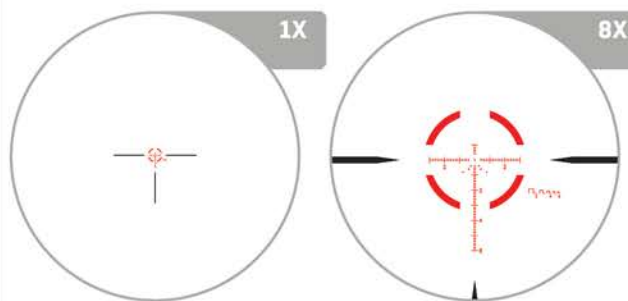

At 1X, a quick-to-acquire T-Dot enclosed within a 68 MOA segmented circle makes close up work, quick and to the point, functioning similarly to a dot sight. At higher magnifications the reticle opens up to provide users with a crisp 1 MOA center dot, range estimation out to 600 yards, and hash marks up to 60 MOA vertically for holdover and 30 MOA horizontally left and right in 2 MOA increments.

	IX801FA1
Focal Plane	FFP
Reticle	Etched Glass A1 MOA
Illumination	Red & Green, 10 Brightness Settings
Magnification	1X - 8X
Tube Diameter	34 mm
Objective Diameter	28 mm
Angular FOV	21.8° - 2.7°
Linear FOV @ 100 yds	115.5' - 14.1'
Linear FOV @ 100 m	38.5 m - 4.7 m
Turret Type	Uncapped Pull to Unlock / Push to Lock
Elevation Travel	Up 60 MOA, Down 40 MOA, Total
Windage Travel	Right 25 MOA, Left 25 MOA
Travel Per Revolution	50 MOA
Eye Relief	3.74" / 95 mm
Exit Pupil	10 mm - 3.5 mm
Diopter	-3D - +2D
Click Value	1/2 MOA
Parallax	Preset @ 100 yds / 91.4 m
Length	10.9" / 277 mm
Weight	25.3 oz / 716 g
Battery Type	CR2032

INTEGRIX™

MID POWER

Arguably the most common amongst hunters and even amongst PRS rifle shooters, mid power optics maximize performance while maintaining a reasonable size and weight. Typically, variable magnification starts at 3x and increases to anywhere between 9x to 18x. Objective diameters come in several sizes and are mostly favored for their great field of view, depth of field, brightness, and definition.





2-12X36 FFP SCOPE / MID POWER

MID
POWER

FFP
FIRST FOCAL PLANE



INTEGRIX™

IX6 2-12X36 FFP / 34MM / MID POWER **NEW**

- » Individually Centration Tested German and Japanese Glass Lenses, Concentric Tested Post Assembly
- » Multi-coated Lenses for Glare, Reflection, and Scratch Resistance
- » Low Aberration Optimized Image Quality with Over a 92% Light Transmission
- » Edge to Edge Sharpness, High Contrast, and High-resolution Standard
- » Reliable Adverse Temperature and Environmental Performance with -40° to 160° Fahrenheit Operational Range and IPX7 Waterproof Rating
- » Rated, at Minimum, for .338 LAPUA Magnum
- » Red and Green Reticle Illumination with 8 Brightness Intensity Settings
- » 12 Hour Automatic Shutoff
- » Side Adjustable Parallax Turret Smoothly and Accurately Adjusts from 30 Yards / 27.4 m to Infinity
- » Intuitive Lockable and Zero Resettable Windage and Elevation Turrets, Serrated and Oversized for Glove Use
- » Serrated Power Ring and Rear Adjustable Eyepiece Diopter
- » Make Transitioning Across Magnification Range Effortless with Included Oversized Throw Lever

ETCHED GLASS A2 MOA RETICLE

(* Refer to P.056-059 for More Info.)

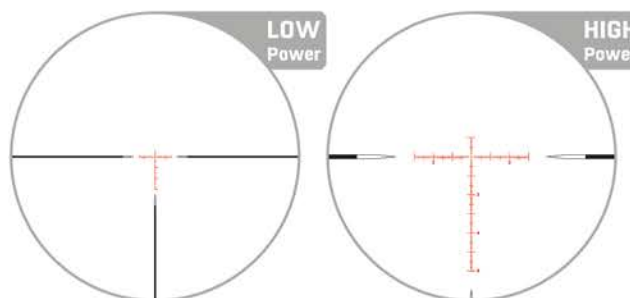

Clutter-free at both low and high magnifications to supplement overall FOV qualities, the German Duplex inspired A2 MOA reticle features sub-tensions that transition from being bolded to see-through while tapering down to a fine point towards the reticle's center. The center crosshair, at low magnification, provides a quick-to-acquire T-Dot and fully illuminates.

The T-Dot at higher magnification opens up and provides an unobtrusive 0.5 MOA floating center dot which focuses the eyes to the center of the reticle and frees up space between it and the remainder of the reticle to provide a better view of critical target details. The reticle spans 10 MOA up and 60 MOA down and 30 MOA left and right in 1 MOA increments.

	IX602FA2
Focal Plane	FFP
Reticle	Etched Glass A2 MOA
Illumination	Red & Green, 8 Brightness Settings
Magnification	2X - 12X
Tube Diameter	34 mm
Objective Diameter	36 mm
Angular FOV	10.9° - 1.8°
Linear FOV @ 100 yds	57.2' - 9.4'
Linear FOV @ 100 m	19.1 m - 3.1 m
Turret Type	Uncapped Pull to Unlock / Push to Lock
Elevation Travel	Up 60 MOA, Down 30 MOA
Windage Travel	Right 12 MOA, Left 12 MOA
Travel Per Revolution	24 MOA
Eye Relief	3.94" / 100 mm
Exit Pupil	10 mm - 3 mm
Diopter	-3D - +2D
Click Value	1/4 MOA
Parallax	10 yds / 9 m - ∞
Length	10.9" / 277 mm
Weight	26.5 oz / 752 g
Battery Type	CR2032

INTEGRIX™



MID POWER

Arguably the most common amongst hunters and even amongst PRS rifle shooters, mid power optics maximize performance while maintaining a reasonable size and weight. Typically, variable magnification starts at 3x and increases to anywhere between 9x to 18x. Objective diameters come in several sizes and are mostly favored for their great field of view, depth of field, brightness, and definition.





3-18X44 FFP SCOPES / MID POWER

MID
POWER

FFP
FIRST FOCAL PLANE



WWW.LEAPERS.COM | SINCE 1992

INTEGRIX™

IX6 3-18X44 FFP / 34MM / MID POWER NEW

- » Individually Centration Tested German and Japanese Glass Lenses, Concentric Tested Post Assembly
- » Multi-coated Lenses for Glare, Reflection, and Scratch Resistance
- » Low Aberration Optimized Image Quality with Over a 92% Light Transmission
- » Edge to Edge Sharpness, High Contrast, and High-resolution Standard
- » Reliable Adverse Temperature and Environmental Performance with -40° to 160° Fahrenheit Operational Range and IPX7 Waterproof Rating
- » Rated, at Minimum, for .338 LAPUA Magnum
- » Red and Green Reticle Illumination with 8 Brightness Intensity Settings
- » 12 Hour Automatic Shutoff
- » Side Adjustable Parallax Turret Smoothly and Accurately Adjusts from 30 Yards / 27.4 m to Infinity
- » Intuitive Lockable and Zero Resettable Windage and Elevation Turrets, Serrated and Oversized for Glove Use
- » Elevation Turret Equipped with Zero Stop
- » Serrated Power Ring and Rear Adjustable Eyepiece Diopter
- » Make Transitioning Across Magnification Range Effortless with Included Oversized Throw Lever

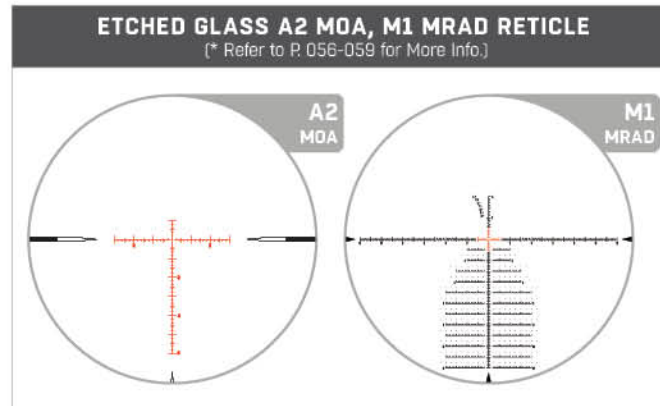

	IX603FA2	IX603FM1
Focal Plane	FFP	
Reticle	Etched Glass A2 MOA	Etched Glass M1 MRAD
Illumination	Red & Green, 8 Brightness Settings	
Magnification	3X - 18X	
Tube Diameter	34 mm	
Objective Diameter	44 mm	
Angular FOV	7.2° - 1.2°	
Linear FOV @ 100 yds	37.7' - 6.3'	
Linear FOV @ 100 m	12.6 m - 2.1 m	
Turret Type	Uncapped Pull to Unlock / Push to Lock with Zero Stop	
Elevation Travel	Up 60 MOA, Down 30 MOA	Up 19 MRAD, Down 13.5 MRAD
Windage Travel	Right 12 MOA, Left 12 MOA	Right 5 MRAD, Left 5 MRAD
Travel Per Revolution	24 MOA	10 MRAD
Eye Relief	3.94" / 100 mm	
Exit Pupil	11 mm - 2.5 mm	
Diopter	-3D - +2D	
Click Value	1/4 MOA	0.1 MRAD
Parallax	30 yds / 27.4 m - ∞	
Length	11.9" / 302 mm	
Weight	29.7 oz / 841 g	
Battery Type	CR2032	

INTEGRIX™



HIGH POWER (LR/ELR)

For long range and extreme long-range engagements, high powered scopes feature some of the largest objective lenses which invite the most amount of light through the system and ultimately transmitted to the eye. A wide magnification range with an extremely high top-end magnification is also inherent. These characteristics amongst others provide the means for shooters, at extremely long ranges, to positively identify, acquire, and engage small targets.





4.5-27X56 FFP SCOPE / LR/ELR

HIGH
POWER

FFP
FIRST FOCAL PLANE



INTEGRIX™

IX6 4.5-27X56 FFP / 34MM / LR/ELR **NEW**

- » Individually Centration Tested German and Japanese Glass Lenses, Concentric Tested Post Assembly
- » Multi-coated Lenses for Glare, Reflection, and Scratch Resistance
- » Low Aberration Optimized Image Quality with Over a 92% Light Transmission
- » Edge to Edge Sharpness, High Contrast, and High-resolution Standard
- » Reliable Adverse Temperature and Environmental Performance with -40° to 160° Fahrenheit Operational Range and IPX7 Waterproof Rating
- » Rated, at Minimum, for .338 LAPUA Magnum
- » Red and Green Reticle Illumination with 8 Brightness Intensity Settings
- » 12 Hour Automatic Shutoff
- » Side Adjustable Parallax Turret Smoothly and Accurately Adjusts from 30 Yards / 27.4 m to Infinity
- » Intuitive Lockable and Zero Resettable Windage and Elevation Turrets, Serrated and Oversized for Glove Use
- » Elevation Turret Equipped with Zero Stop
- » Serrated Power Ring and Rear Adjustable Eyepiece Diopter
- » Make Transitioning Across Magnification Range Effortless with Included Oversized Throw Lever
- » US PAT. D979005S

ETCHED GLASS M1, M2 MRAD RETICLES

(* Refer to P.056-059 for More Info.)

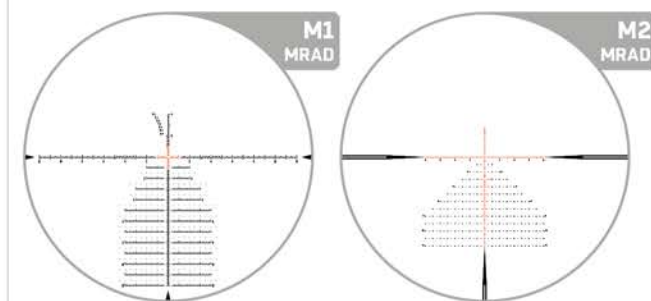

	IX645FM1	IX645FM2
Focal Plane	FFP	
Reticle	Etched Glass M1 MRAD	Etched Glass M2 MRAD
Illumination	Red & Green, 8 Brightness Settings	
Magnification	4.5X - 27X	
Tube Diameter	34 mm	
Objective Diameter	56 mm	
Angular FOV	4.8° - 0.8°	
Linear FOV @ 100 yds	25.1' - 4.2'	
Linear FOV @ 100 m	8.4 m - 1.4 m	
Turret Type	Uncapped Pull to Unlock / Push to Lock with Zero Stop	
Elevation Travel	Up 19 MRAD, Down 13.5 MRAD	
Windage Travel	Right 5 MRAD, Left 5 MRAD	
Travel Per Revolution	10 MRAD	
Eye Relief	3.94" / 100 mm	
Exit Pupil	11 mm - 2.1 mm	
Diopter	-3D - +2D	
Click Value	0.1 MRAD	
Parallax	30 yds / 27.4 m - ∞	
Length	14.1" / 359 mm	
Weight	33.7 oz / 956 g	
Battery Type	CR2032	

INTEGRIX™



LOW POWER [LPVO]

A popular choice for the AR15 platform and other similar carbines that see a variety of dynamic and on-the-move close to medium range engagements. With its variable magnification starting at 1x and ending at higher magnifications typically under 10x, LPVOs excel in versatility and are often considered to be a great general-purpose solution.





1-8X28 SFP SCOPE / LPVO

LOW
POWER

SFP
SECOND FOCAL PLANE



INTEGRIX™

IX8 1-8X28 SFP / 34MM / LPVO **NEW**

- » Individually Centration Tested German and Japanese Glass Lenses, Concentric Tested Post Assembly
- » Multi-coated Lenses for Glare, Reflection, and Scratch Resistance
- » Low Aberration Optimized Image Quality with Over a 92% Light Transmission
- » Edge to Edge Sharpness, High Contrast, and High-resolution Standard
- » Reliable Adverse Temperature and Environmental Performance with -40° to 160° Fahrenheit Operational Range and IPX7 Waterproof Rating
- » Rated, at Minimum, for .338 LAPUA Magnum
- » Red and Green Reticle Illumination with 10 Brightness Intensity Settings
- » 12 Hour Automatic Shutoff
- » Intuitive Lockable and Zero Resettable Windage and Elevation Turrets, Serrated and Oversized for Glove Use
- » Serrated Power Ring and Rear Adjustable Eyepiece Diopter
- » Make Transitioning Across Magnification Range Effortless with Included Oversized Throw Lever

ETCHED GLASS A3 MOA RETICLE

(* Refer to P. 056-059 for More Info.)

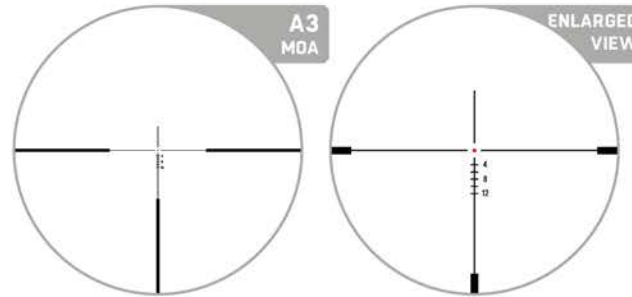

Derived from the traditional German 4 reticle and catered towards the IPSC rifle shooter is our A3 MOA Reticle. This reticle showcases three 2 MOA thick stadia coming in from the outer edges and traversing towards the center in a similar fashion to that of a duplex and stepping down in thickness to ¼ MOA along the way. The focal point boasts a 1 MOA floating dot which illuminates, ensuring the utmost precision for your center hold. Moreover, the reticle offers MOA holdover marks, extending up to 12 MOA for those moments where you require more reach.

	IX801SA3
Focal Plane	SFP
Reticle	Etched Glass A3 MOA
Illumination	Red & Green, 10 Brightness Settings
Magnification	1X - 8X
Tube Diameter	34 mm
Objective Diameter	28 mm
Angular FOV	21.8° - 2.7°
Linear FOV @ 100 yds	115.5' - 14.1'
Linear FOV @ 100 m	38.5 m - 4.7 m
Turret Type	Uncapped Pull to Unlock / Push to Lock
Elevation Travel	Up 60 MOA, Down 40 MOA
Windage Travel	Right 25 MOA, Left 25 MOA
Travel Per Revolution	50 MOA
Eye Relief	3.74" / 95 mm
Exit Pupil	10 mm - 3.5 mm
Diopter	-3D - +2D
Click Value	1/2 MOA
Parallax	Preset @ 100 yds / 91.4 m
Length	10.9" / 277 mm
Weight	25.3 oz / 716 g
Battery Type	CR2032

BALANCE PERFECTED.





ACCUSHOT PRO™

For the shooters searching for solid all-around performance, ACCUSHOT PRO™ optics feature a similar build quality and feature set to that of our premier INTEGRIX™ optics line, but at an entry point more accessible to others. Balance is perfected every step of the way from design, manufacturing, to performance downrange.

Take with you into the field our years of heritage and experience top-end features, clarity, and quality with ACCUSHOT PRO™ close, mid, and long-range optics. Suited for the task at hand, valued by shooters, and brought to you by Leapers.



BALANCE PERFECTED.
YEARS OF HERITAGE.
GREATER ACCESSIBILITY.
THIS IS ACCUSHOT PRO™

ACCUSHOT PRO™

BALANCE PERFECTED. SHOOTER DRIVEN.

ALL-AROUND PERFORMANCE.

Mid-tier brand optics priced accordingly and leveraging qualities from our premium INTEGRIX™ scopes. Fully utilizing over 30 years of experience, this is our most balanced scope brand having optimized shooter driven functionality, feature set, and build quality at a fair price.

CONSTANT EYE RELIEF

Maintains a Constant Eye Relief Throughout Its Entire Magnification Range.

QUICK ACQUIRE ADJUSTMENT

Uncapped Lockable and Zero Resettable W/E Turrets and Serrated Power Ring with Optional Throw Lever Included.

DIOPTER ADJUSTMENT

The Wide Range of the Diopter Allows the Scope to be Fine-tuned to the User's Unique Vision for Optimized Reticle Clarity and Sharpness.

SIDE TURRET

Variable Red and Green Reticle Illumination Adjustment with 12 Hour Automatic Shutoff.
Side Parallax Adjustment.

POWER RING

Optional Extended Throw Lever Included.

Effortless Transitioning Across Magnification Range.

OPTIMIZED CLARITY

90% Light Transmission for Vivid Viewfinder Clarity with Sharp-focus Glass-etched Reticle Options.





DYNAMIC LIVE FIRE TESTING

Field Tested for Specific Applications and Professional Qualification.



DURABLE ONE-PIECE CONSTRUCTION

Solid Block of Aluminum CNC Machined for Rigidity.

ACCUSHOT PRO™

FIND WHAT'S RIGHT FOR YOU

LOW POWER [LPVO]

A popular choice for the AR15 platform and other similar carbines that see a variety of dynamic and on-the-move close to medium range engagements. With its variable magnification starting at 1x and ending at higher magnifications typically under 10x, LPVDs excel in versatility and are often considered to be a great general-purpose solution.

LOW
POWER



- 1-6x24 / A1 MOA Reticle / FFP (pg.035)
- 1-6x24 / B1 BDC Reticle / FFP (pg.035)
- 1-6x24 / A3 MOA Reticle / SFP (pg.039)

MID POWER

Arguably the most common amongst hunters and even amongst PRS rifle shooters, mid power optics maximize performance while maintaining a reasonable size and weight. Typically, variable magnification starts at 3x and increases to anywhere between 9x to 18x. Objective diameters come in several sizes and are mostly favored for their great field of view, depth of field, brightness, and definition.

MID
POWER



- 3-9x36 / A2 MOA Reticle / FFP (pg.037)

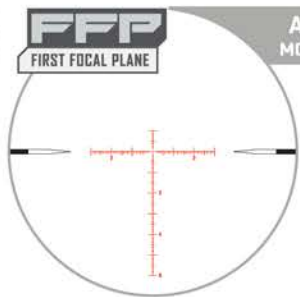
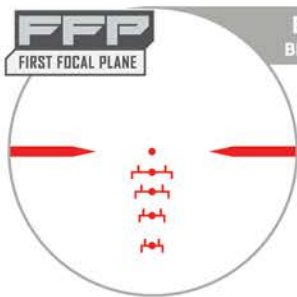
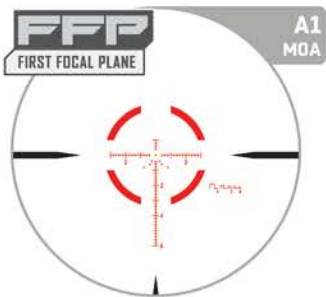

ACCUSHOT PRO™

LOW POWER [LPVO]

A popular choice for the AR15 platform and other similar carbines that see a variety of dynamic and on-the-move close to medium range engagements. With its variable magnification starting at 1x and ending at higher magnifications typically under 10x, LPVOs excel in versatility and are often considered to be a great general-purpose solution.





1-6X24 FFP SCOPES / LPVO

LOW
POWER

FFP
FIRST FOCAL PLANE



ACCUSHOT PRO™

AS6 1-6X24 FFP / 34MM / LPVO **NEW**

- » Multi-coated Lenses for Optimized Image Quality
- » Sharp 90% Light Transmission with High Definition Clarity and Contrast
- » Reliable Adverse Temperature and Environmental Performance with -40° to 160°F Operational Range and IPX7 Waterproof Rating
- » Red and Green Reticle Illumination with 10 Brightness Intensity Settings
- » 5,000+ Hours Battery Life with 12 Hour Automatic Shutoff
- » Serrated Lockable and Zero Resettable W/E Turrets
- » Serrated Adjustable Eyepiece Diopter and Power Ring
- » Includes Optional Oversized Power Ring Throw Lever and Flip Open Lens Caps

ETCHED GLASS A1 MOA RETICLE

(* Refer to P. 056-059 for More Info.)

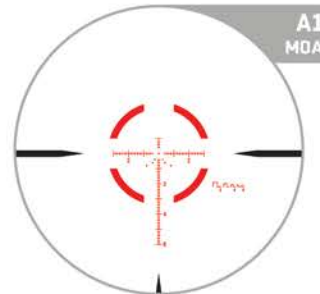

ETCHED GLASS B1 BDC RETICLE

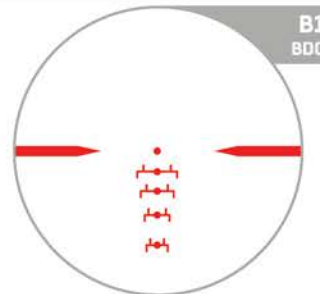

	AS601FA1	AS601FB1
Focal Plane	FFP	
Reticle	Etched Glass A1 MOA	Etched Glass B1 BDC
Illumination	Red & Green, 10 Brightness Settings	
Magnification	1X - 6X	
Tube Diameter	34 mm	
Objective Diameter	24 mm	
Angular FOV	21.8° - 3.6°	
Linear FOV @ 100 yds	115.5' - 18.9'	
Linear FOV @ 100 m	38.5 m - 6.3 m	
Elevation Travel	Up 60 MOA, Down 40 MOA	
Windage Travel	Right 20 MOA, Left 20 MOA	
Travel Per Revolution	40 MOA	
Eye Relief	3.54" / 90 mm	
Exit Pupil	9.5 mm - 4.0 mm	
Diopter	-3D - +2D	
Click Value	1/2 MOA	
Parallax	Preset @ 100 yds / 91.4 m	
Length	10" / 255 mm	
Weight	22.6 oz / 642 g	
Battery Type	CR2032	

ACCUSHOT PRO™



MID POWER

Arguably the most common amongst hunters and even amongst PRS rifle shooters, mid power optics maximize performance while maintaining a reasonable size and weight. Typically, variable magnification starts at 3x and increases to anywhere between 9x to 18x. Objective diameters come in several sizes and are mostly favored for their great field of view, depth of field, brightness, and definition.



TM



3-9X36 FFP SCOPE / MID POWER



ACCUSHOT PRO™

AS3 3-9X36 FFP / 34MM / MID POWER

NEW

- » Multi-coated Lenses for Optimized Image Quality
- » Sharp 90% Light Transmission with High Definition Clarity and Contrast
- » Clutter-free German Duplex Inspired Etched-glass MOA Illuminated Reticle
- » Reliable Adverse Temperature and Environmental Performance with -40° to 160°F Operational Range and IPX7 Waterproof Rating
- » Red and Green Reticle Illumination with 8 Brightness Intensity Settings
- » 800+ Hours Battery Life with 12 Hour Automatic Shutoff
- » Uniquely Compact for its Magnification Class with Serrated Lockable and Zero Resettable W/E Turrets
- » Serrated Adjustable Eyepiece Diopter and Power Ring
- » Includes Optional Oversized Power Ring Throw Lever and Flip Open Lens Caps

ETCHED GLASS A2 MOA RETICLE

(* Refer to P.056-059 for More Info.)

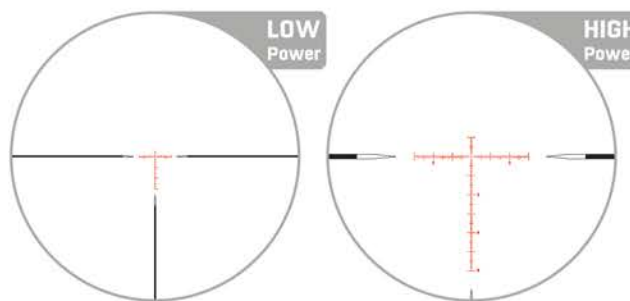

Clutter-free at both low and high magnifications to supplement overall FOV qualities, the German Duplex inspired A2 MOA reticle features sub-tensions that transition from being bolded to see-through while tapering down to a fine point towards the reticle's center. The center crosshair, at low magnification, provides a quick-to-acquire T-Dot and fully illuminates.

The T-Dot at higher magnification opens up and provides an unobtrusive 0.5 MOA floating center dot which focuses the eyes to the center of the reticle and frees up space between it and the remainder of the reticle to provide a better view of critical target details. The reticle spans 10 MOA up and 60 MOA down and 30 MOA left and right in 1 MOA increments.

	AS303FA2
Focal Plane	FFP
Reticle	Etched Glass A2 MOA
Illumination	Red & Green, 8 Brightness Settings
Magnification	3X - 9X
Tube Diameter	34 mm
Objective Diameter	36 mm
Angular FOV	7.4° - 2.47°
Linear FOV @ 100 yds	38.8' - 12.9'
Linear FOV @ 100 m	12.9 m - 4.3 m
Elevation Travel	Up 60 MOA, Down 40 MOA
Windage Travel	Right 10 MOA, Left 10 MOA
Travel Per Revolution	20 MOA
Eye Relief	3.54" / 90 mm
Exit Pupil	12 mm - 4 mm
Diopter	-3D - +2D
Click Value	1/4 MOA
Parallax	10 yds / 9.14 m - ∞
Length	9.4" / 239 mm
Weight	21.9 oz / 620 g
Battery Type	CR2032

ACCUSHOT PRO™



LOW POWER [LPVO]

A popular choice for the AR15 platform and other similar carbines that see a variety of dynamic and on-the-move close to medium range engagements. With its variable magnification starting at 1x and ending at higher magnifications typically under 10x, LPVOs excel in versatility and are often considered to be a great general-purpose solution.





1-6X24 SFP SCOPE / LPVO

LOW
POWER

SFP
SECOND FOCAL PLANE



ACCUSHOT PRO™

AS6 1-6X24 SFP / 34MM / LPVO NEW

- » Multi-coated Lenses for Optimized Image Quality
- » Sharp 90% Light Transmission with High Definition Clarity and Contrast
- » Reliable Adverse Temperature and Environmental Performance with -40° to 160°F Operational Range and IPX7 Waterproof Rating
- » Red and Green Reticle Illumination with 10 Brightness Intensity Settings
- » 5,000+ Hours Battery Life with 12 Hour Automatic Shutoff
- » Serrated Flat Profile Lockable and Zero Resettable W/E Turrets
- » Serrated Adjustable Eyepiece Diopter and Power Ring
- » Includes Optional Oversized Power Ring Throw Lever and Flip Open Lens Caps

ETCHED GLASS A3 MOA RETICLE

(* Refer to P. 056-059 for More Info.)

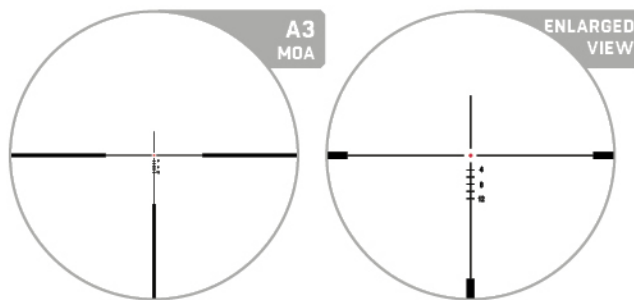

Derived from the traditional German 4 reticle and catered towards the IPSC rifle shooter is our A3 MOA Reticle. This reticle showcases three 2 MOA thick stadia coming in from the outer edges and traversing towards the center in a similar fashion to that of a duplex and stepping down in thickness to ¼ MOA along the way. The focal point boasts a 1 MOA floating dot which illuminates, ensuring the utmost precision for your center hold. Moreover, the reticle offers MOA holdover marks, extending up to 12 MOA for those moments where you require more reach.

	AS601SA3
Focal Plane	SFP
Reticle	Etched Glass A3 MOA
Illumination	Red & Green, 10 Brightness Settings
Magnification	1X - 6X
Tube Diameter	34 mm
Objective Diameter	24 mm
Angular FOV	21.8° - 3.6°
Linear FOV @ 100 yds	115.5' - 18.9'
Linear FOV @ 100 m	38.5 m - 6.3 m
Elevation Travel	Up 60 MOA, Down 40 MOA
Windage Travel	Right 20 MOA, Left 20 MOA
Travel Per Revolution	40 MOA
Eye Relief	3.54" / 90 mm
Exit Pupil	9.5 mm - 4.0 mm
Diopter	-3D - +2D
Click Value	1/2 MOA
Parallax	Preset @ 100 yds / 91.4 m
Length	10.1" / 256 mm
Weight	22.8 oz / 645 g
Battery Type	CR2032





UTG[®]

Our grassroots brand that has been a constant in the marketplace and in the hands of shooting enthusiasts since our establishment over 30 years ago. From the days of plinking with our first 10/22 to the present, UTG[®] scopes have been a common go-to for affordable hunting and shooting sports optics that deliver complete solutions out-of-the-box.

Known by many of our customers, the proven TRUE STRENGTH[®] platform, an advanced sealed recoil system at the core of every UTG[®] scope, provides legendary shockproof, fogproof, and rainproof performance. Shooters who find value in application-specific features, but within a large variety to choose from look to UTG[®], an essential collection and foundation that continues to pave the way for the new and the experienced.



GRASSROOTS FOUNDATION
VAST OPTIONS
COMPLETE SOLUTIONS
THIS IS UTG[®]

UTG®

VAST OPTIONS. COMPLETE SOLUTIONS.

HERITAGE SINCE 1992.

Leapers' grassroots optics brand. UTG® scopes provide customers with solutions set out to be both affordable and complete. An essential collection and foundation that continues to pave the way for new and experienced hunting and shooting sports enthusiasts alike.

TRUE STRENGTH® RECOIL PROOF SYSTEM

User-friendly Windage and Elevation Adjustment System with Innovative Design, Precision Components, and Disciplined Assembly.



EZ-TAP® ILLUMINATION ENHANCED

Accommodate Environment, Light, and Weather Conditions with Red & Green Dual Color and 36 Multi-color Illumination Modes Standard on Most Models.



SMART SPHERICAL STRUCTURE [SSS]

The erector tube is constrained via a ball and socket structural relationship, which provides the desirable flexibility to respond to windage and elevation adjustments and the optimal ability to hold zero under heavy recoil.

EMERALD LENS COATINGS

Reduced Reflection and Balanced Light Transmission for Optimized Clarity.

TRUE STRENGTH® PLATFORM

Strengthened Inner to Outer Tube Interface Reinforces W/E Turret Response, Precision, and Resistance to Recoil for Shock, Rain, and Fog Proof Performance.



AN ARRAY OF OPTIONS

1" and 30mm Offerings with Models and Reticles Catered to Close, Mid, and Long Ranges.

COMPLETE SOLUTIONS

Ready to Install Out-of-the-box with the Majority of Models Coming Included with Scope Rings, Lens Caps, and More.

MULTIPLE APPLICATIONS

Something for Everyone to Include Specialized Crossbow, Pistol, and Long Eye Relief Scopes.

BACKED FOR LIFE

Take with You Peace of Mind with a Lifetime Warranty that Delivers.



UTG®

SCP3 SCOPES

- 1-8X28 / 30 MM / BG4 / SFP (pg.045)
- 3-12X44 / 30 MM / MIL-DOT / SFP (pg.045)
- 4-16X44 / 30 MM / MIL-DOT / SFP (pg.045)

FIND WHAT YOU NEED



OP3 SCOPES

- 3-12X44 / 30 MM / UMOA / SFP (PG.047)
- 4-16X44 / 30 MM / UMOA / SFP (PG.047)



BUG BUSTER SCOPES

- 3-9X32 / 1" / MIL-DOT / SFP (PG.049)
- 3-12X32 / 1" / MIL-DOT / SFP (PG.049)



TRUE HUNTER SCOPES

- 3-9X40 / 1" / MIL-DOT / SFP (PG.051)
- 4-16X40 / 1" / MIL-DOT / SFP (PG.051)
- 4X32 / 1" / MIL-DOT / SFP (PG.051)
- 6-24X50 / 1" / MIL-DOT / SFP (PG.051)



CROSSBOW SCOPES

- 4X32 / 1" / PRO 5-STEP / SFP (PG.053)
- 1.5-6X36 / 30 MM / 130 HUNTER BDC / SFP (PG.053)



LONG EYE RELIEF SCOPES

- 2-7X44 / 30 MM / MIL-DOT / SFP (PG.055)
- 2-7X32 / 1" / PDC / SFP (PG.055)





UTG® SCP3 SCOPES

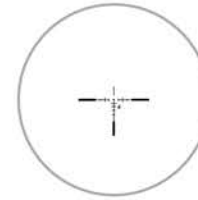

1-8X28 / SFP / 30 MM
ETCHED GLASS BG4 / IE® 36-COLOR
 / SCP3-18IEBG4

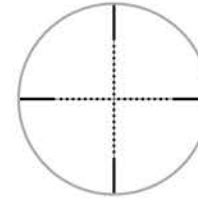

3-12X44 / SFP / 30 MM
WIRE MIL-DOT / IE® 36-COLOR
 / SCP3-U312AOIEW
 / SCP3-UM312AOIEW

4-16X44 / SFP / 30 MM
WIRE MIL-DOT / IE® 36-COLOR
 / SCP3-U416AOIEW
 / SCP3-UM416AOIEW

US PAT. 8437079
 EU PAT. EP2520894

	SCP3-18IEBG4	SCP3-U312AOIEW	SCP3-UM312AOIEW	SCP3-U416AOIEW	SCP3-UM416AOIEW
Focal Plane	SFP	SFP	SFP	SFP	SFP
Reticle	Etched Glass BG4	Wire Mil-Dot	Wire Mil-Dot	Wire Mil-Dot	Wire Mil-Dot
Illumination	IE® 36-Color	IE® 36-Color	IE® 36-Color	IE® 36-Color	IE® 36-Color
Magnification	1X - 8X	3X - 12X	3X - 12X	4X - 16X	4X - 16X
Tube Diameter	30 mm	30 mm	30 mm	30 mm	30 mm
Objective Diameter	28 mm	44 mm	44 mm	44 mm	44 mm
Angular FOV	18.8° - 2.5°	6.5° - 1.6°	6.1° - 1.9°	4.7° - 1.3°	5° - 1.5°
Linear FOV @ 100 yds	99.5' - 13.0'	34.0' - 8.5'	32.0' - 10.0'	24.4' - 6.8'	26.2' - 7.85'
Eye Relief	5" - 3.35" / 127 mm - 85 mm	3.3" - 3.0" / 84 mm - 76 mm	3.4" - 3.0" / 86 mm - 76 mm	3.2" - 3.0" / 81 mm - 76 mm	3.4" - 3.0" / 86 mm - 76 mm
Exit Pupil	26.5 mm - 3.4 mm	13.1 mm - 3.7 mm	13.0 mm - 3.9 mm	10.2 mm - 2.8 mm	11.0 mm - 2.7 mm
Diopter	-2D - +2D	-2D - +2D	-2D - +2D	-2D - +2D	-2D - +2D
Click Value	1/2"	1/4"	1/4"	1/4"	1/4"
Parallax	Preset @ 100 yds	10 yds - ∞	10 yds - ∞	10 yds - ∞	10 yds - ∞
Length	10.2" / 259 mm	14.0" / 356 mm	11.1" / 282 mm	15.4" / 391 mm	11.2" / 284 mm
Weight	18.0 oz / 510 g	22.7 oz / 644 g	23.2 oz / 658 g	23.4 oz / 663 g	21.8 oz / 618 g
Battery Type	CR2032 3V	CR2032 3V	CR2032 3V	CR2032 3V	CR2032 3V
Included Scope Rings	AIR32234 Picatinny High Profile	RG2W3154 Picatinny Medium Profile			

OPTIONAL ACCESSORIES

PARALLAX INDEX WHEEL

» Compatible with UTG® SCP3 Series Side AD Scopes

60 mm / SCP-SW060B
80 mm / SCP-SW080B



RUBBER SCOPE EYESHADE

» Designed to Fit Scopes with Approximately 3" Eye Relief
 » Adaptor Kit Includes 3 Inserts of Varying Thicknesses to Fit Scopes with Eyepiece Diameter of 36mm, 40mm, 41.5mm or 43mm

/ SCP-ES403





UTG® OP3 SCOPES



3-12X44 / SFP / 30 MM
ETCHED GLASS UMOA / IE® 36-COLOR
 / OP3-GM3124UMOA

4-16X44 / SFP / 30 MM
ETCHED GLASS UMOA / IE® 36-COLOR
 / OP3-GM4164UMOA

UTG® OP3 OPTICS

- » Improved Sharpness through Optimization of Internal Light Transmission Pathway, Lens Quality, and Low Aberration
- » Improved Circuitry Prevents Intermittent Illumination and Features Lower Power Consumption
- » Multi-coated Lenses for Optimal Light Transmission and High Definition Sharpness
- » Crisp and Tactile Turret Movement with Consistent Per Click Adjustment
- » Reinforced Zero Locking/Resetting Target Turrets
- » Side Parallax Adjustment from 10 Yards to Infinity
- » Set Once Locking Eyepiece Diopter
- » Wider Turret for Use with Gloves
- » Threaded for Included Sunshade
- » IPX7 Waterproof Rated
- » US PAT. 8437079, EU PAT. EP2520894

	OP3-GM3124UMOA	OP3-GM4164UMOA
Focal Plane	SFP	SFP
Reticle	Etched Glass UMOA	Etched Glass UMOA
Illumination	IE® 36-Color	IE® 36-Color
Magnification	3X - 12X	4X - 16X
Tube Diameter	30 mm	30 mm
Objective Diameter	44 mm	44 mm
Angular FOV	6.1° - 1.9°	5° - 1.5°
Linear FOV @ 100 yds	32' - 10'	26.2' - 8'
Eye Relief	4" - 3.54" / 102 mm - 90 mm	3.7" - 3.23" / 94 mm - 82 mm
Exit Pupil	14.7 mm - 4.5 mm	11 mm - 3 mm
Diopter	-2D - +2D	-2D - +2D
Click Value	1/4 MOA	1/4 MOA
Parallax	10 yds - ∞	10 yds - ∞
Length	10.1" / 257 mm	10.7" / 272 mm
Weight	20.7 oz / 587 g	21.4 oz / 607 g
Battery Type	CR2032 3V	CR2032 3V
Included Scope Rings	RG2W3154 Picatinny Medium Profile	

OPTIONAL ACCESSORIES

PARALLAX INDEX WHEEL

- » Compatible with UTG® OP3 Series Side AD Scopes, OP3-GM3124UMOA, OP3-GM4164UMOA Only
- 80 mm / OP3-SW080**



UG GUSTER®



UTG® BUG BUSTER® SCOPES

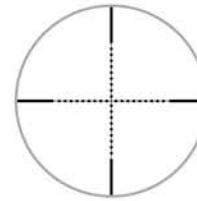

**3-9X32 / SFP / 1" / FRONT AO
WIRE MIL-DOT / IE® 36-COLOR**

/ SCP-M392AOIEWQ

US PAT. 8437079
US PAT. 8397421
EU PAT. EP2520894

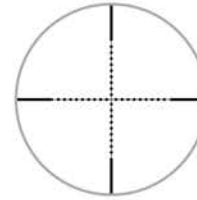

**3-9X32 / SFP / 1" / FRONT AO
WIRE MIL-DOT / RG**

/ SCP-M392AOLWQ

US PAT. 8397421

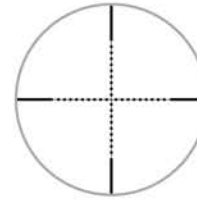

**3-12X32 / SFP / 1" / SIDE AO
WIRE MIL-DOT**

/ SCP-M312AOWQ

/ SCP-M312AOD

	SCP-M392AOIEWQ	SCP-M392AOLWQ	SCP-M312AOWQ	SCP-M312AOD
Focal Plane	SFP	SFP	SFP	SFP
Reticle	Wire Mil-Dot	Wire Mil-Dot	Wire Mil-Dot	Wire Mil-Dot
Illumination	IE® 36-Color	RG	N/A	N/A
Magnification	3X - 9X	3X - 9X	3X - 12X	3X - 12X
Tube Diameter	1"	1"	1"	1"
Objective Diameter	32 mm	32 mm	32 mm	32 mm
Angular FOV	7.2° - 2.7°	7.2° - 2.7°	5.9° - 1.9°	5.9° - 1.9°
Linear FOV @ 100 yds	37.7' - 14.0'	37.7' - 14.0'	31.0' - 10.0'	31.0' - 10.0'
Eye Relief	4.2" - 3.2" / 107 mm - 81 mm	4.2" - 3.2" / 107 mm - 81 mm	4.3" - 3.3" / 109 mm - 84 mm	4.3" - 3.3" / 109 mm - 84 mm
Exit Pupil	10.6 mm - 3.6 mm	10.6 mm - 3.6 mm	10.6 mm - 2.7 mm	10.6 mm - 2.7 mm
Diopter	-2D - +2D	-2D - +2D	-2D - +2D	-2D - +2D
Click Value	1/4 MOA	1/4 MOA	1/3 MOA	1/3 MOA
Parallax	3 yds - ∞	3 yds - ∞	3 yds - ∞	3 yds - ∞
Length	8.2" / 208 mm	8.2" / 208 mm	8.1" / 206 mm	8.1" / 206 mm
Weight	14.0 oz / 397 g	14.0 oz / 397 g	12.7 oz / 360 g	12.7 oz / 360 g
Battery Type	CR1632 3V	CR1620 3V	N/A	N/A
Included Scope Rings	RQ2W1154 Picatinny Medium Profile			RT2D1154 Dovetail Medium Profile

OPTIONAL ACCESSORIES

PARALLAX INDEX WHEEL

>> Compatible with Side AO BUG BUSTER® Optic, SCP-M312AOWQ, SCP-M312AOD Only

80 mm / SCP-SW080BB



TRUE HUNTER®



UTG® TRUE HUNTER® SCOPES

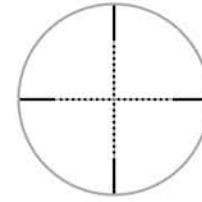

3-9X40 / SFP / 1"
WIRE MIL-DOT / IE® 36-COLOR
 / SCP-U394A0IED
 / SCP-U394A0IEW

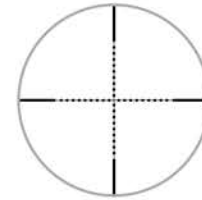

4-16X40 / SFP / 1"
WIRE MIL-DOT / IE® 36-COLOR
 / SCP-U4164A0IEW

US PAT. 8437079, EU PAT. EP2520894

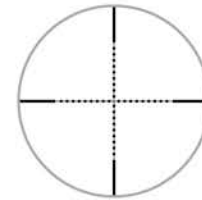

6-24X50 / SFP / 1"
WIRE MIL-DOT / IE® 36-COLOR
 / SCP-U6245A0IEW

US PAT. 8437079, EU PAT. EP2520894

WWW.LEAPERS.COM | SINCE 1992

	SCP-U394A0IEW	SCP-U394A0IED	SCP-U4164A0IEW	SCP-U432FD	SCP-U6245A0IEW
Focal Plane	SFP	SFP	SFP	SFP	SFP
Reticle	Wire Mil-Dot	Wire Mil-Dot	Wire Mil-Dot	Wire Mil-Dot	Wire Mil-Dot
Illumination	IE® 36-Color	IE® 36-Color	IE® 36-Color	N/A	IE® 36-Color
Magnification	3X - 9X	3X - 9X	4X - 16X	4X	6X - 24X
Tube Diameter	1"	1"	1"	1"	1"
Objective Diameter	40 mm	40 mm	40 mm	32 mm	50 mm
Angular FOV	6.8° - 2.3°	6.8° - 2.3°	4.4° - 1.1°	6.1°	2.7° - 0.8°
Linear FOV @ 100 yds	35.6' - 12'	35.6' - 12'	23.0' - 6.0'	32'	14.4' - 4.1'
Eye Relief	3.9" - 3.2" / 99 mm - 81 mm	3.9" - 3.2" / 99 mm - 81 mm	3.2" - 3.0" / 81 mm - 76 mm	3.4" / 86 mm	3.2" - 3.0" / 81 mm - 76 mm
Exit Pupil	13 mm - 4.5 mm	13 mm - 4.5 mm	10.0 mm - 2.5 mm	8.0 mm	8.3 mm - 2.2 mm
Diopter	-2D - +2D	-2D - +2D	-2D - +2D	-2D - +2D	-2D - +2D
Click Value	1/4"	1/4"	1/4"	1/4"	1/4"
Parallax	5 yds - ∞	5 yds - ∞	5 yds - ∞	Preset @ 35 yds	10 yds - ∞
Length	12.6" / 320 mm	12.6" / 320 mm	14.5" / 368 mm	11.8" / 300 mm	15.5" / 394 mm
Weight	21.1 oz / 598 g	21.1 oz / 598 g	22.3 oz / 632 g	14.4 oz / 408 g	26.5 oz / 751 g
Battery Type	CR2032 3V	CR2032 3V	CR2032 3V	N/A	CR2032 3V
Included Scope Rings	RQ2W1204 Picatinny High Profile	RGPM-25M4 Dovetail High Profile	RGWM-25H4 Picatinny High Profile	RGPM-25M2 Dovetail Medium Profile	RQ2W1204 Picatinny High Profile

OPTIONAL ACCESSORIES

RUBBER SCOPE EYE SHADE

- » Designed to Fit Scopes with Approximately 3" Eye Relief
- » Prevents Glare and Improves Focus on Target by Eliminating Distractions from Peripheral Movement
- » Adaptor Kit Includes 3 Inserts of Varying Thicknesses to Fit Scopes with Eyepiece Diameter of 36mm, 40mm, 41.5mm or 43mm

/ SCP-ES403





UTG® CROSSBOW SCOPES



UTG® TRUE HUNTER® CROSSBOW SCOPE

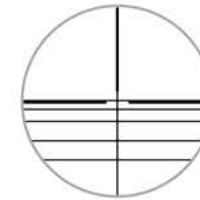

4X32 / SFP / 1"
PRO 5-STEP / RG
 / SCP-M4CR5WQ
 US PAT. 8397421



UTG® OP3 CROSSBOW SCOPE

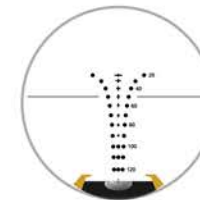

1.5-6X36 / SFP / 30 MM
ETCHED GLASS 130 HUNTER BDC / RG
 / OP3-G1563CRWQ

130 HUNTER BDC RETICLE

The bubble leveler is internal and is not a separate external attachment. Located unobtrusively at the 6 o'clock position, the bubble leveler aids in correcting any cant the user may have while aiming. Being internal allows the user to focus their attention primarily on the target and reticle, while secondarily allowing for quick cant adjustments by seeing the leveler through their peripherals.

RANGE ESTIMATION

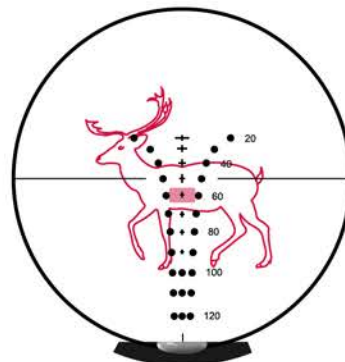
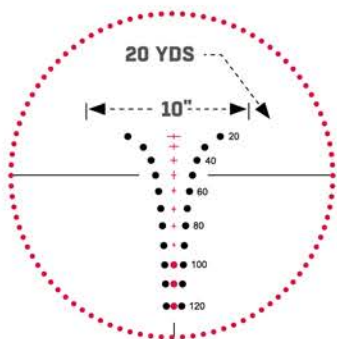

	OP3-G1563CRWQ	SCP-M4CR5WQ
Focal Plane	SFP	SFP
Reticle	Etched Glass 130 Hunter	Wire PRO 5-Step
Illumination	RG	RG
Magnification	FPS Compensation 250 - 475 (1.5X - 6X)	4X
Tube Diameter	30 mm	1"
Objective Diameter	36 mm	32 mm
Angular FOV	10° - 2.7°	5.2°
Linear FOV @ 100 yds	52.5' - 13.98'	27.2'
Eye Relief	5.8" - 4.25" / 147 mm - 108 mm	3.8" / 97 mm
Exit Pupil	24 mm - 6.2 mm	8.0 mm
Diopter	-2D - +2D	-2D - +2D
Click Value	1/2 MOA	1/4"
Parallax	10 yds - ∞	Preset @ 50 yds
Length	8.2" / 208 mm	8.2" / 208 mm
Weight	16.0 oz / 454 g	12.3 oz / 349 g
Battery Type	CR1632 3V	CR1620 3V
Included Scope Rings	RG2W3154 Picatinny Medium Profile	RQ2W1104 Picatinny Low Profile



UTG® LONG EYE RELIEF SCOPES



UTG® SCP3 SCOUT SCOPE

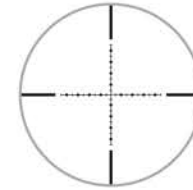

2-7X44 / SFP / 30MM
ETCHED GLASS MIL-DOT / IE® 36-COLOR
/ SCP3-274LA0IEW
 US PAT. 8437079, EU PAT. EP2520894

UTG® TRUE HUNTER® HANDGUN SCOPE

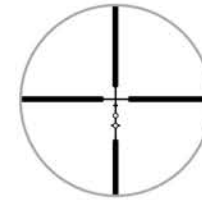

2-7X32 / SFP / 1"
PDC / RG
/ SCP-27PRGW

UTG® LONG EYE RELIEF SCOPES

- » Built on TRUE STRENGTH® Platform, Completely Sealed and Nitrogen Filled, Shockproof, Fogproof and Rainproof
- » Most Consistent and Precise 1/4 MDA per Click Windage/Elevation Adjustment
- » Emerald Coated Lenses to Achieve Maximum Light Transmission for Best Clarity

	SCP3-274LA0IEW	SCP-27PRGW
Focal Plane	SFP	SFP
Reticle	Etched Mil-Dot	Wire PDC
Illumination	IE® 36-Color	RG
Magnification	2X - 7X	2X - 7X
Tube Diameter	30 mm	1"
Objective Diameter	44 mm	32 mm
Angular FOV	6.1° - 1.9°	2.5° - 1.3°
Linear FOV @ 100 yds	32.0' - 10.0'	12.9' - 7.0'
Eye Relief	11.0" - 9.5" / 279 mm - 241 mm	25.0" - 13.8" / 635 mm - 351 mm
Exit Pupil	22.0 mm - 6.3 mm	16.0 mm - 5.0 mm
Diopter	-2D - +2D	-2D - +2D
Click Value	1/4"	1/4"
Parallax	10 yds - Infinity	Preset @ 35 yds
Length	11.5" / 292 mm	9.4" / 239 mm
Weight	25.4 oz / 720 g	14.0 oz / 397 g
Battery Type	CR2032 3V	CR1620 3V
Included Scope Rings	RG2W3154 Picatinny 30 mm / Medium Profile	RGWM-25M4 Picatinny 1" / Medium Profile

**GLASS RETICLE RANGE-ESTIMATING
A1 MOA**

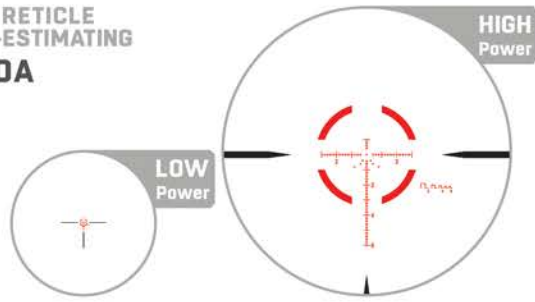

At 1X, a quick-to-acquire T-Dot enclosed within a 68 MOA segmented circle makes close up work, quick and to the point, functioning similarly to a dot sight. At higher magnifications the reticle opens up to provide users with a crisp 1 MOA center dot, range estimation out to 600 yards, and hash marks up to 60 MOA vertically for holdover and 30 MOA horizontally left and right in 2 MOA increments.

- >> IX801FA1 / 1-8X28mm / RG (pg.021) **NEW**
- >> AS601FA1 / 1-6X24mm / RG (pg.035) **NEW**

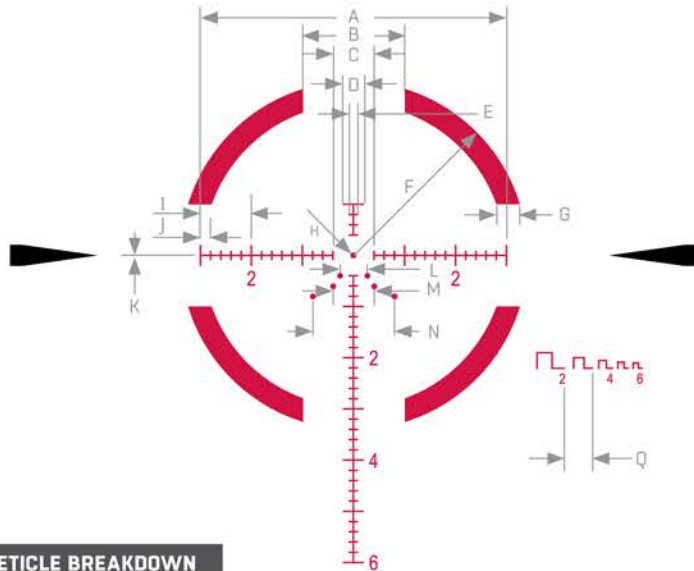

RETICLE BREAKDOWN

Unit	A	B	C	D	E	F	G	H	I	J	K
MOA	60	20	8	4	2	34	4	1	10	2	0.25

18 INCH TARGET RANGING

Unit	L	M	N	Q
in @ 100yds			18	
in @ 200yds		18		
in @ 300yds	18			18

**GLASS RETICLE
A2 MOA**

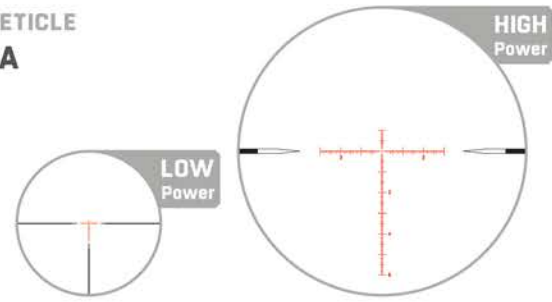

Clutter-free at both low and high magnifications to supplement overall FOV qualities, the German Duplex inspired A2 MOA reticle features sub-tensions that transition from being bolded to see-through while tapering down to a fine point towards the reticle's center. The center crosshair, at low magnification, provides a quick-to-acquire T-Dot and fully illuminates.

The T-Dot at higher magnification opens up and provides an unobtrusive 0.5 MOA floating center dot which focuses the eyes to the center of the reticle and frees up space between it and the remainder of the reticle to provide a better view of critical target details. The reticle spans 10 MOA up and 60 MOA down and 30 MOA left and right in 1 MOA increments.

- >> IX602FA2 / 2-12X36mm / RG (pg.023) **NEW**
- >> IX603FA2 / 3-18X44mm / RG (pg.025) **NEW**
- >> AS303FA2 / 3-9X36mm / RG (pg.037) **NEW**

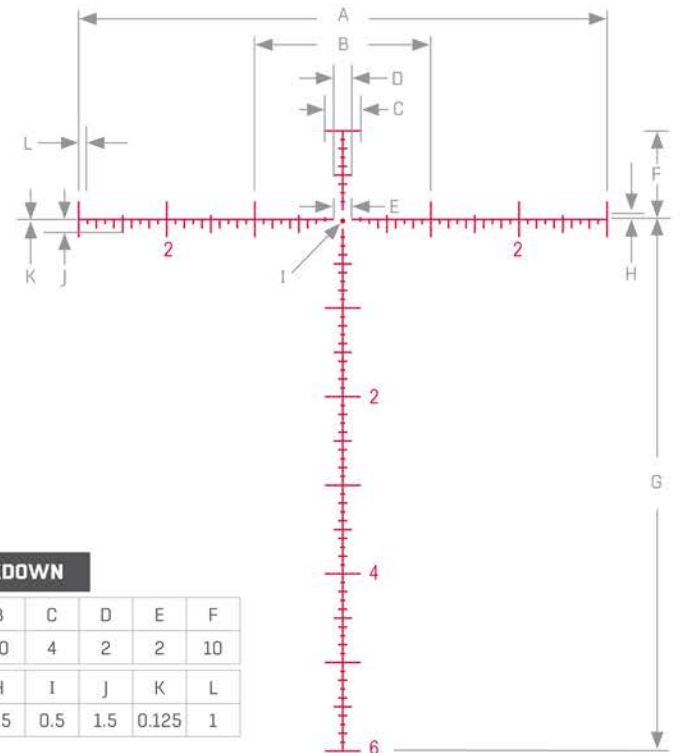

RETICLE BREAKDOWN

Unit	A	B	C	D	E	F
MOA	60	20	4	2	2	10

Unit	G	H	I	J	K	L
MOA	60	0.5	0.5	1.5	0.125	1

MOA RETICLES

GLASS RETICLE
A3 MOA

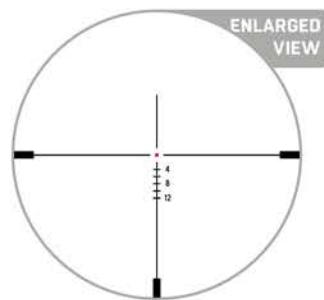

Derived from the traditional German 4 reticle and catered towards the IPSC rifle shooter is our A3 MOA Reticle. This reticle showcases three 2 MOA thick stadia coming in from the outer edges and traversing towards the center in a similar fashion to that of a duplex and stepping down in thickness to ¼ MOA along the way. The focal point boasts a 1 MOA floating dot which illuminates, ensuring the utmost precision for your center hold. Moreover, the reticle offers MOA holdover marks, extending up to 12 MOA for those moments where you require more reach.

- » IX801SA3 / 1-8X28mm / RG (pg.029) **NEW**
- » AS601SA3 / 1-6X24mm / RG (pg.039) **NEW**

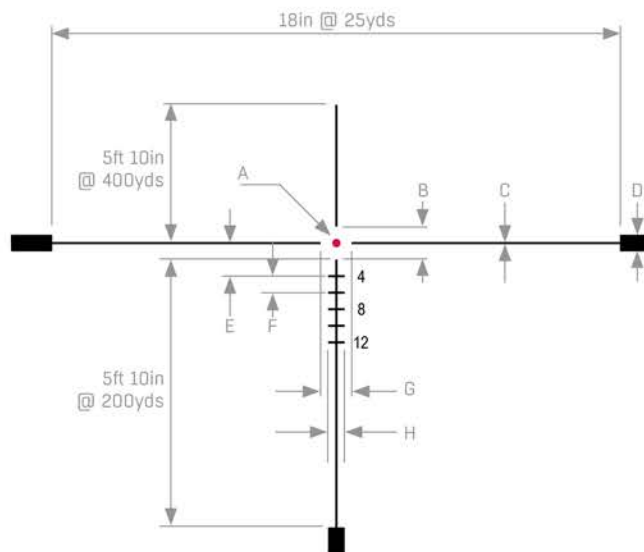

RETICLE BREAKDOWN

Unit	A	B	C	D	E	F	G	H
MOA	1	4	0.25	2	4	2	4	2

GLASS RETICLE
UMOA



The UMOA reticle features hash marks at minute of angle increments for precise range estimation and bullet drop and wind drift compensation. This reticle is the best choice for long-range precision shooters who want clear adjustments and to rapidly calculate holds. The reticle's center crosshair can be illuminated to assist aiming under different light conditions.

- » OP3-GM3124UMOA / 3-12X44mm / IE 36-Color (pg.047)
- » OP3-GM4164UMOA / 4-16X44mm / IE 36-Color (pg.047)

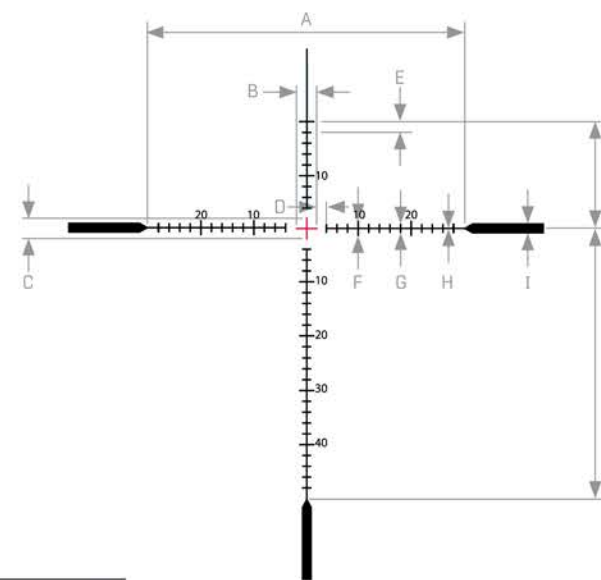

RETICLE BREAKDOWN

Unit	A	B	C	D	E	F	G	H	I	J	K
MOA	60	4	4	2	2	2	1	0.2	1.3	20	60

MRAD RETICLES

GLASS RETICLE
M1 MRAD

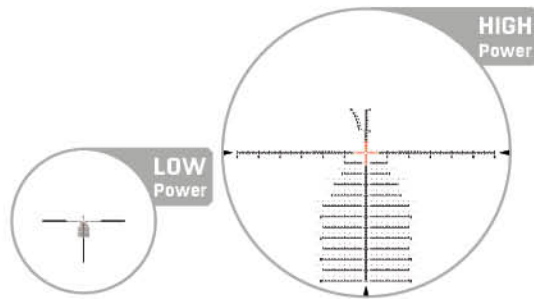

A tried-and-true MRAD Reticle made for true marksmen looking to challenge themselves at ranges most could not reach. 12 Mils of holdovers broken into .2 Mil increments for exact shot placement. Four Mils of hold-under for that prairie dog that pops up a little close and a 1 Mil section of .1 Mil increments for fine measuring, if you know you know. Twenty-four Mils of wind holds on the main horizontal stadia includes 2 Mils of .1 Mil increments on both sides.

Do not be afraid to have fun in the wind with up to 4.5 Mils of wind holds. Finally, if you feel like just dialing, a 0.05 Mil dot for your center hold will prove to be the precise aiming point needed to hit your mark. The center hold and one Mil of the crosshairs are the only parts of the M1 MRAD reticle that illuminates.

- » IX603FM1 / 3-18X44mm / RG (pg.025) **NEW**
- » IX645FM1 / 4.5-27X56mm / RG (pg.027) **NEW**

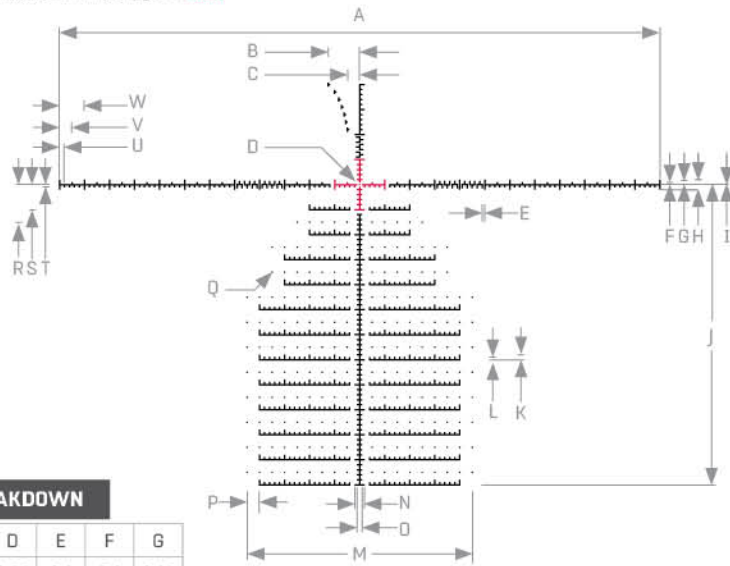

RETICLE BREAKDOWN

Unit	A	D	E	F	G
MRAD	24	0.05	0.1	0.1	0.15

Unit	H	I	J	K	L	M	N	O	P	Q	R	S	T	U	V	W
MRAD	0.4	0.03	12	0.2	0.1	9	0.4	0.2	0.5	0.05	1.5	1	0.1	0.2	0.5	1

18 INCH TARGET RANGING

Unit	B	Unit	C
in @ 400yds	18	in @ 1000yds	18

GLASS RETICLE
M2 MRAD

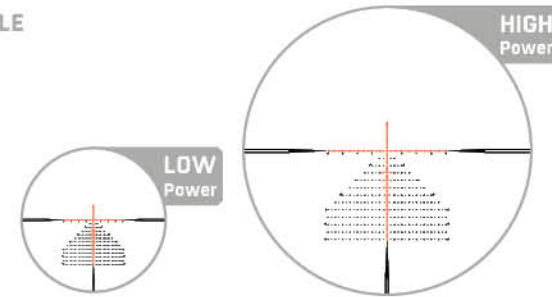

A modern clutter free and minimalist MRAD reticle, built for the tactical yet simple marksman. A wide-open top half of the glass makes the most of your FOV with a .1 Mil floating donut as your center hold. Additional holds can be found throughout the main vertical stadia spaced out in 1 Mil increments. Wind holds are also spaced out in 1 Mil increments out to 6 Mils. Your main horizontal stadia has .2 Mil increments on the bottom and .5 Mil hashes up top with 2 Mils of .1 Mil increments for fine measuring found on both sides. Your main vertical stadia is spaced out in .2 Mil increments with .5 Mil markings in the center of the segments. 2 Mils of .1 Mil increments are also applied to this stadia. We have included ranging brackets from 300 yards out to 1,000 for targets 6-9 inches or 12-18 inches wide. The main stadia's and the ranging brackets will be the only illuminated portions of the reticle.

- » IX645FM2 / 4.5-27X56mm / RG (pg.027) **NEW**

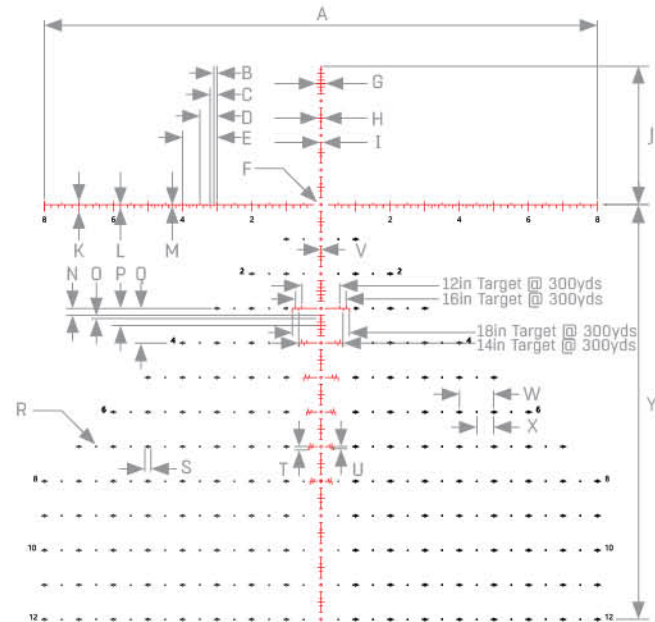

RETICLE BREAKDOWN

Unit	A	B	C	D	E	F	G	H	I	J	K	L	M
MRAD	16	0.1	0.2	0.5	1	0.1	0.3	0.2	0.1	4	0.3	0.1	0.05

Unit	N	O	P	Q	R	S	T	U	V	W	X	Y
MRAD	0.2	0.1	0.5	1	0.05	0.12	0.1	0.075	0.02	1	0.5	12

GLASS RETICLE MIL-DOT

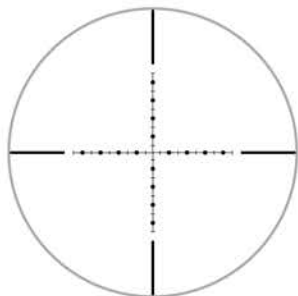

The crosshair has dots and dashes spread equally along the X and Y axis. The distance between two adjacent marks subtends to 1 milli-radian. The etched-glass reticle offers our discerning users the sharpest Mil-dot reticle for precise range estimation.

» SCP3-274LADIEW / 2-7X44mm / IE 36-Color (pg.055)

WIRE RETICLE MIL-DOT

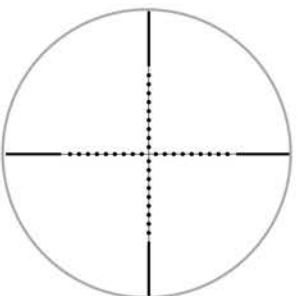

The crosshair has multiple dots spread equally along the X and Y axis. The distance between two adjacent marks subtends to 1 milli-radian. The traditional wire reticle is robust and holds up against strong recoil and offers a clear aiming reference without compromise.

- » SCP3-U312ADIEW / 3-12X44mm / IE 36-Color (pg.045)
- » SCP3-U416ADIEW / 4-16X44mm / IE 36-Color (pg.045)
- » SCP3-UM312ADIEW / 3-12X44mm / IE 36-Color (pg.045)
- » SCP3-UM416ADIEW / 4-16X44mm / IE 36-Color (pg.045)
- » SCP-M392ADIEWQ / 3-9X32mm / IE 36-Color (pg.049)
- » SCP-U394ADIED / 3-9X40mm / IE 36-Color (pg.051)
- » SCP-U394ADIEW / 3-9X40mm / IE 36-Color (pg.047)
- » SCP-U4164ADIEW / 4-16X40mm / IE 36-Color (pg.051)
- » SCP-U6245ADIEW / 4-24X50mm / IE 36-Color (pg.051)
- » SCP-M392AQLWQ / 3-9X32mm / RG (pg.049)
- » SCP-U432FD / 4X32mm / RG (pg.051)
- » SCP-M312AOD / 3-12X32mm (pg.049)
- » SCP-M312AOWQ / 3-12X32mm (pg.049)

BDC RETICLES

GLASS RETICLE B1 BDC

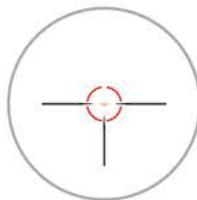

For up-close work at low magnification, a segmented circle surrounds a T-Dot crosshair for placing shots quickly on target. Tapered sub-tensions like that of a German Duplex draws the eyes to the center of the reticle.

At higher magnification, the T-dot crosshair features a simple floating 1 MOA dot. Just below the 1 MOA dot are four additional 1 MOA dots for holdovers at 300, 400, 500, and 600 yards. Each holdover dot is accompanied by range estimating brackets. Determining the range to target is easily accomplished by sizing up the targets' shoulder width within the correct bracket. The segmented circle and T-dot crosshair are the only parts of the B1 BDC reticle that illuminates.

» AS601FB1 / 1-6X24mm / RG (pg.031) **NEW**

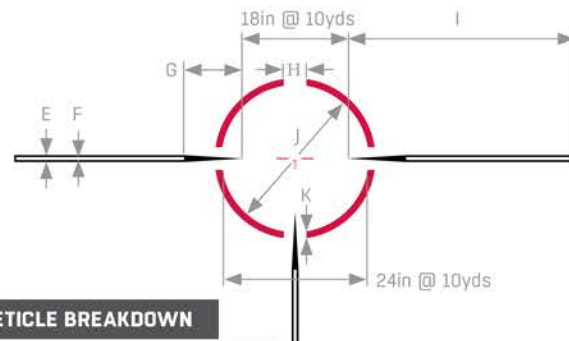
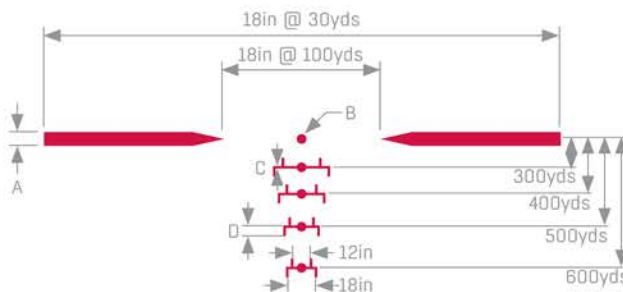

RETICLE BREAKDOWN

Unit	A	B	C	D
MRAD	0.3	0.2	0.08	0.3

Unit	E	F	G	H	I	J	K
MRAD	3	1.4	25	10	100	65	3

GLASS RETICLE BG4

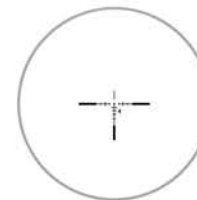

The BG4 reticle is designed to be fast and intuitive to use and features ballistic drop compensation and range finder markings out to 600 yards. The ballistic data is based on common 5.56/.223 loadings in modern sporting rifles. The three tick posts draw the eye to the center for rapid acquisition at close range,

while the drop compensation allows for rapid engagement of targets throughout the platform's effective range.

» SCP3-18IEBG4 / 1-8X18mm / RG (pg.045)

WIRE RETICLE PRO 5-STEP

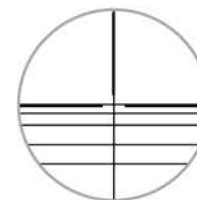

The Pro 5-step reticle is designed for crossbows. The reticle consists of five horizontal lines and a vertical line, with a thin center crosshair. The horizontal lines are for aiming at 10, 20, 30, 40, and 50 yard distances, calibrated for 300fps crossbows.

» SCP-M4CR5WQ / 4X32mm / RG (pg.053)

GLASS RETICLE 130 HUNTER BDC



The 130 Hunter reticle features a "through the viewfinder" bubble leveler located at the 6 o'clock and ballistic drop compensation and range estimating markers out to 130 yards. Markers found down the central spine of the reticle illuminate and are calibrated to match crossbow ballistics from 20 yards up to 130 yards using 10 yard increments. The center of the reticle marker is calibrated for a 50 yard target distance for general ease of use.

» DP3-G1563CRWQ / 1.5-6X36mm / RG (pg.053)

WIRE RETICLE PDC



The Projectile Drop Compensation (PDC) reticle uses different bars and circles arranged at designated heights to aid in range estimation and serve as aiming points set at predetermined distances. This enables easy and rapid target engagement at multiple ranges.

» SCP-27PRGW / 2-7X32mm / RG (pg.055)

SPECIFICATIONS

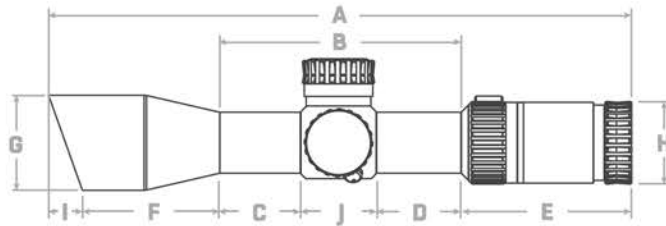

FIND WHAT

SKU#	DIMENSIONS (NOTE: DIMENSIONS MEASURED IN INCHES)											MAGNIFICATION		OBJECTIVE DIA.	TUBE DIA.	FOCAL PLANE	RETICLE	ILLUMINATION	ANGULAR FOV	LINEAR FOV	
	A	B	C	D	E	F	G	H	I	J	Low	High	mm				degrees	ft @ 100 yds	m @ 100 m		
INTEGRIX™																					
IX602FA2	10.9	5.3	2.0	1.8	3.5	2.1	1.8	1.8	-	1.5	2	12	36	34 mm	FFP	Glass	A2 MOA	RG	10.9 - 1.8	57.2 - 9.4	19.1 - 3.1
IX603FA2	11.9	5.3	1.8	1.9	3.5	3.2	2.1	1.8	-	1.6	3	18	44	34 mm	FFP	Glass	A2 MOA	RG	7.2 - 1.2	37.7 - 6.3	12.6 - 2.1
IX603FM1	11.9	5.3	1.8	1.9	3.5	3.2	2.1	1.8	-	1.6	3	18	44	34 mm	FFP	Glass	M1 MRAD	RG	7.2 - 1.2	37.7 - 6.3	12.6 - 2.1
IX645FM1/M2	14.0	5.7	2.0	2.0	3.5	4.8	2.6	1.8	-	1.7	4.5	27	56	34 mm	FFP	Glass	M1/M2 MRAD	RG	4.8 - 0.8	25.1 - 4.2	8.4 - 1.4
IX801FA1	10.9	6.4	2.2	2.6	3.4	1.1	1.4	1.8	-	1.6	1	8	28	34 mm	FFP	Glass	A1 MOA	RG	21.8 - 2.7	115.5 - 14.1	38.5 - 4.7
IX801SA3	10.9	6.4	2.2	2.6	3.4	1.1	1.4	1.8	-	1.6	1	8	28	34 mm	SFP	Glass	A3 MOA	RG	21.8 - 2.7	115.5 - 14.1	38.5 - 4.7
ACCUSHOT PRO™																					
AS601FB1/FA1	10.0	6.6	3.3	1.7	3.5	-	1.3	1.8	-	1.6	1	6	24	34 mm	FFP	Glass	B1 BDC / A1 MOA	RG	21.8 - 3.6	115.5 - 18.9	38.5 - 6.3
AS303FA2	9.4	4.4	1.6	1.2	3.0	2.1	1.7	1.7	-	1.6	3	9	36	34 mm	FFP	Glass	A2 MOA	RG	7.4 - 2.5	38.8 - 12.9	12.9 - 4.3
AS601SA3	10.1	6.6	3.3	1.7	3.5	-	1.7	1.8	-	1.6	1	6	24	34 mm	SFP	Glass	A3 MOA	RG	21.8 - 3.6	115.5 - 18.9	38.5 - 6.3
UTG®																					
SCP3-18IEBG4	9.8	4.5	1.6	1.6	3.8	1.5	1.4	1.6	0.4	1.3	1	8	28	30 mm	SFP	Glass	BG4	IE 36-Color	18.8 - 2.5	99.5 - 13.0	33.1 - 4.4
SCP3-U312A0IEW	13.0	5.5	2.1	2.0	3.9	3.7	2.1	1.7	1.0	1.4	3	12	44	30 mm	SFP	Wire	Mil-dot	IE 36-Color	6.5 - 1.6	34 - 8.5	11.4 - 2.8
SCP3-U416A0IEW	14.4	6.8	3.0	2.4	3.9	3.7	2.1	1.7	1.0	1.4	4	16	44	30 mm	SFP	Wire	Mil-dot	IE 36-Color	4.7 - 1.3	24.4 - 6.8	8.2 - 2.3
SCP3-UM312A0IEW	9.8	4.0	1.3	1.4	2.9	3.1	2.1	1.6	0.6	1.3	3	12	44	30 mm	SFP	Wire	Mil-dot	IE 36-Color	6.1 - 1.9	32.0 - 10.0	10.7 - 3.3
SCP3-UM416A0IEW	10.6	4.4	1.6	1.5	3.1	3.1	2.1	1.6	0.6	1.3	4	16	44	30 mm	SFP	Wire	Mil-dot	IE 36-Color	5.0 - 1.5	26.2 - 7.85	8.7 - 2.6
OP3-GM3124UMOA	10.2	4.0	1.2	1.2	3.1	3.0	2.1	1.6	-	1.6	3	12	44	30 mm	SFP	Glass	UMOA	IE 36-Color	6.1 - 1.9	32 - 10	10.7 - 3.3
OP3-GM4164UMOA	10.7	4.2	1.4	1.4	3.1	3.3	2.1	1.6	-	1.5	4	16	44	30 mm	SFP	Glass	UMOA	IE 36-Color	5.0 - 1.5	26.2 - 8	8.7 - 2.6
SCP-M312A0D	8.1	3.7	1.3	1.2	2.2	2.1	1.5	1.5	-	1.2	3	12	32	1 in	SFP	Wire	Mil-dot	-	5.9 - 1.9	31.0 - 10.0	10.3 - 3.1
SCP-M312A0WQ	8.1	3.7	1.3	1.2	2.2	2.1	1.5	1.5	-	1.2	3	12	32	1 in	SFP	Wire	Mil-dot	-	5.9 - 1.9	31.0 - 10.0	10.3 - 3.1
SCP-M392A0IEWQ	8.5	3.3	1.1	1.1	2.6	2.6	1.8	1.5	-	1.2	3	9	32	1 in	SFP	Wire	Mil-dot	IE 36-Color	7.2 - 2.7	37.7 - 14.0	12.6 - 4.7
SCP-M392A0LWQ	8.1	3.3	1.1	1.1	2.2	2.5	1.8	1.5	-	1.2	3	9	32	1 in	SFP	Wire	Mil-dot	RG	7.2 - 2.7	37.7 - 14.0	12.6 - 4.7
SCP-U394A0IED	12.6	4.6	1.7	1.7	3.6	4.4	2.0	1.6	-	1.4	3	9	40	1 in	SFP	Wire	Mil-dot	IE 36-Color	6.8 - 2.3	35.6 - 12.0	11.9 - 4.0
SCP-U394A0IEW	12.6	4.6	1.7	1.7	3.6	4.4	2.0	1.6	-	1.4	3	9	40	1 in	SFP	Wire	Mil-dot	IE 36-Color	6.8 - 2.3	35.6 - 12.0	11.9 - 4.0
SCP-U4164A0IEW	14.6	6.0	2.3	2.4	3.7	5.0	2.0	1.6	-	1.3	4	16	40	1 in	SFP	Wire	Mil-dot	IE 36-Color	4.4 - 1.1	23.0 - 6.0	7.7 - 1.9
SCP-U432FD	11.7	5.8	2.4	2.2	2.9	3.0	1.7	1.6	0.6	1.2	4	-	32	1 in	SFP	Wire	Mil-dot	-	6.1	32.0	10.7
SCP-U6245A0IEW	15.2	6.5	2.6	2.6	3.7	5.1	2.4	1.6	-	1.2	6	24	50	1 in	SFP	Wire	Mil-dot	IE 36-Color	2.7 - 0.8	14.4 - 4.1	4.7 - 1.4
OP3-G1563CRWQ	8.3	3.5	1.2	1.1	2.9	1.9	1.7	1.7	-	1.3	1.5	6	36	30 mm	SFP	Glass	130 Hunter	RG	10 - 2.7	52.5 - 13.98	17.5 - 4.7
SCP-M4CR5WQ	8.2	3.5	1.2	1.2	2.0	2.1	1.7	1.5	0.4	1.2	4	-	32	1 in	SFP	Wire	PRO 5-Step	RG	5.2	27.2	9.1
SCP-27PRGW	9.4	3.7	1.3	1.2	3.3	2.4	1.6	1.7	-	1.1	2	7	32	1 in	SFP	Wire	PDC	RG	2.5 - 1.3	12.9 - 7.0	4.4 - 2.3
SCP3-274LA0IEW	10.9	4.1	1.3	1.4	3.8	3.0	2.1	1.8	0.6	1.3	2	7	44	30 mm	SFP	Glass	Mil-dot	IE 36-Color	6.0 - 1.9	32.0 - 10.0	10.5 - 3.1

WHAT'S RIGHT FOR YOU

ELEVATION TRAVEL		WINDAGE TRAVEL		TRAVEL PER REVOLUTION	EYE RELIEF		EXIT PUPIL	DIOPTR	CLICK VALUE	PARALLAX		WEIGHT		SKU#
Up	Down	Right	Left		inch	mm	mm			yds	m	oz	g	
INTEGRIX™														
60 MOA	30 MOA	12 MOA	12 MOA	24 MOA	3.94	100	10 - 3	-3D ~ +2D	1/4 MOA	10 - ∞	9 - ∞	26.5	752	IX602FA2
60 MOA	30 MOA	12 MOA	12 MOA	24 MOA	3.94	100	11 - 2.5	-3D ~ +2D	1/4 MOA	30 - ∞	27.4 - ∞	29.7	841	IX603FA2
19 MRAD	13.5 MRAD	5 MRAD	5 MRAD	10 MRAD	3.94	100	11 - 2.5	-3D ~ +2D	0.1 MRAD	30 - ∞	27.4 - ∞	29.7	841	IX603FM1
19 MRAD	13.5 MRAD	5 MRAD	5 MRAD	10 MRAD	3.94	100	11 - 2.1	-3D ~ +2D	0.1 MRAD	30 - ∞	27.4 - ∞	33.7	956	IX645FM1/M2
60 MOA	40 MOA	25 MOA	25 MOA	50 MOA	3.74	95	10 - 3.5	-3D ~ +2D	1/2 MOA	100	91.4	25.3	716	IX801FA1
60 MOA	40 MOA	25 MOA	25 MOA	50 MOA	3.74	95	10 - 3.5	-3D ~ +2D	1/2 MOA	100	91.4	25.3	716	IX801SA3
ACCUSHOT PRO™														
60 MOA	40 MOA	20 MOA	20 MOA	40 MOA	3.54"	90	9.5 - 4	-3D ~ +2D	1/2 MOA	100	91.4	22.6	642	AS601FB1/FA1
60 MOA	40 MOA	10 MOA	10 MOA	20 MOA	3.54"	90	4 - 12	-3D ~ +2D	1/4 MOA	10 - ∞	9.14 - ∞	21.9	620	AS303FA2
60 MOA	40 MOA	20 MOA	20 MOA	40 MOA	3.54"	90	9.5 - 4	-3D ~ +2D	1/2 MOA	100	91.4	22.8	645	AS601SA3
UTG®														
40 MOA	40 MOA	40 MOA	40 MOA	30 MOA	5-3.35	127-85	26.5 - 3.4	-2D ~ +2D	1/2"	100	91.4	18.0	510	SCP3-18IEBG4
40 MOA	40 MOA	40 MOA	40 MOA	18 MOA	3.3-3.0	84-76	13.1 - 3.7	-2D ~ +2D	1/4"	10 - ∞	9 - ∞	22.7	644	SCP3-U312AOIEW
40 MOA	40 MOA	40 MOA	40 MOA	18 MOA	3.2-3.0	81-76	10.2 - 2.8	-2D ~ +2D	1/4"	10 - ∞	9 - ∞	23.4	663	SCP3-U416AOIEW
40 MOA	40 MOA	40 MOA	40 MOA	18 MOA	3.4-3.0	86-76	13 - 3.9	-2D ~ +2D	1/4"	10 - ∞	9 - ∞	23.2	658	SCP3-UM312AOIEW
40 MOA	40 MOA	40 MOA	40 MOA	18 MOA	3.4-3.0	86-76	11 - 2.8	-2D ~ +2D	1/4"	10 - ∞	9 - ∞	21.8	618	SCP3-UM416AOIEW
40 MOA	40 MOA	40 MOA	40 MOA	26 MOA	4.0-3.5	102-90	14.7 - 4.5	-2D ~ +2D	1/4 MOA	10 - ∞	9 - ∞	20.7	587	OP3-GM3124UMOA
40 MOA	40 MOA	40 MOA	40 MOA	26 MOA	3.7-3.2	94-82	11 - 3	-2D ~ +2D	1/4 MOA	10 - ∞	9 - ∞	21.4	607	OP3-GM4164UMOA
40 MOA	40 MOA	40 MOA	40 MOA	24 MOA	4.3-3.3	109-84	10.6 - 2.7	-2D ~ +2D	1/3 MOA	3 - ∞	2.74 - ∞	12.7	360	SCP-M312A0D
40 MOA	40 MOA	40 MOA	40 MOA	24 MOA	4.3-3.3	109-84	10.6 - 2.7	-2D ~ +2D	1/3 MOA	3 - ∞	2.74 - ∞	12.7	360	SCP-M312A0WQ
40 MOA	40 MOA	40 MOA	40 MOA	18 MOA	4.2-3.2	107-81	10.6 - 3.6	-2D ~ +2D	1/4 MOA	3 - ∞	2.74 - ∞	14.0	397	SCP-M392AOIEWQ
40 MOA	40 MOA	40 MOA	40 MOA	18 MOA	4.2-3.2	107-81	10.6 - 3.6	-2D ~ +2D	1/4 MOA	3 - ∞	2.74 - ∞	14.0	397	SCP-M392A0LWQ
40 MOA	40 MOA	40 MOA	40 MOA	15 MOA	3.9-3.2	99-81	13 - 4.5	-2D ~ +2D	1/4"	5 - ∞	4.57 - ∞	21.1	598	SCP-U394A0IED
40 MOA	40 MOA	40 MOA	40 MOA	15 MOA	3.9-3.2	99-81	13 - 4.5	-2D ~ +2D	1/4"	5 - ∞	4.57 - ∞	21.1	598	SCP-U394A0IEW
40 MOA	40 MOA	40 MOA	40 MOA	15 MOA	3.2-3.0	81-76	10 - 2.5	-2D ~ +2D	1/4"	5 - ∞	4.57 - ∞	22.3	632	SCP-U416AOIEW
40 MOA	40 MOA	40 MOA	40 MOA	20 MOA	3.40	86	8.0	-2D ~ +2D	1/4"	35	32	14.4	408	SCP-U432FD
40 MOA	40 MOA	40 MOA	40 MOA	15 MOA	3.2-3.0	81-76	8.3 - 2.2	-2D ~ +2D	1/4"	10 - ∞	9 - ∞	26.5	751	SCP-U6245AOIEW
40 MOA	40 MOA	40 MOA	40 MOA	36 MOA	5.8-4.3	147-108	24 - 6.2	-2D ~ +2D	1/2 MOA	10 - ∞	9 - ∞	16.0	454	OP3-G1563CRWQ
40 MOA	40 MOA	40 MOA	40 MOA	20 MOA	3.8"	97	8.0	-2D ~ +2D	1/4"	50	45.7	12.3	349	SCP-M4CR5WQ
40 MOA	40 MOA	40 MOA	40 MOA	15 MOA	25.0-13.8	635-351	16 - 5.0	-2D ~ +2D	1/4"	35	32	14.0	397	SCP-27PRGW
40 MOA	40 MOA	40 MOA	40 MOA	18 MOA	11.0-9.5	279-241	22.0 - 6.3	-2D ~ +2D	1/4"	10 - ∞	9 - ∞	25.4	720	SCP3-274LA0IEW



DOT SIGHTS & MAGNIFIERS

CONFIDENCE SQUARED AWAY.

Effective targeting solutions viable for handguns, shotguns, and rifles with a wide selection of MRDS (Micro Reflex Dot Sights) and other closed-emitter dot sights to choose from. Follow through with confidence as you transition between targets and find what suits you as a shooter with different reticle options, adaptive bases, height profiles, and more. Looking to touch our father? Pair one with our three times flip-to-side magnifier.



JUMP TO A SERIES

	UTG® ACCU-SYNC® DOT SIGHTS [NEW]	064
	DS2521R for Mini ACOG® Footprint	065
	DS2018R for Mini ACOG® Footprint	065
	UTG® OP3 MICRO MRDS	066
	Mini Micro MRDS for SHIELD RMSC Footprint	066
	MRDS/SL/SLS for DOCTER® Footprint	067
	MRDS/SLS for RMR® Footprint	067
	UTG® 3X FLIP-TO-SIDE MAGNIFIER	068
	UTG® ITA DOT SIGHTS	068

[THIRD PARTY TRADEMARKS MAY BE USED IN THIS CATALOG FOR USER CONVENIENCE TO INDICATE THE FIT OR COMPATIBILITY OF THE APPLICABLE PRODUCT.]





ACCURACY SYNCHRONIZED ACCU-SYNC®

ACCU-SYNC® DOT SIGHTS

UTG® ACCU-SYNC® dot sights come in a compact and subcompact size and feature a red illuminated 3 MDA dot with 8 manually adjusted brightness intensity settings to choose from. Illumination memory conveniently gets users right back to the last brightness setting used upon activation. Fully sealed, ACCU-SYNC® dot sights are IPX7 waterproof rated and constructed from matte black anodized 6061-T6 aluminum. Optimized for low power consumption and powered by a single CR2032 battery, a 30,000+ hour battery life (at middle brightness) comes standard.

The mounting base uses the common mini ACOG® footprint and is configured for a lower 1/3 co-witness out of the box. Removing the included riser drops the height down to that of a low mount providing users two commonly used height profiles for different firearm applications. In addition, the base features squared recoil stops and our QR (quick release) mount, making for a quick installation and removal, reliable return to zero, and is compatible with Picatinny rails with widths that may even be out of spec. Tool-free tension adjustment is locked in place via a gear and spring-loaded locking lever interface, allowing users to set it once and forget it.

QUICK TO ACQUIRE

Red 3 MDA Dot with 8 Brightness Settings and 30,000+ Hours Battery Life



SHOOTER CONFIGURABLE

Includes Low Mount & Lower 1/3 Riser and is Mini ACOG Footprint Compatible



ACCU-SYNC® QR

Low Profile Quick Release (QR) Mount with Tool-free Tension Adjustment



RELIABLE CONSTRUCTION

IPX7 Waterproof Rated, Precision Machined from Matte Black 6061-T6 Aluminum with Impact Resistant Tempered Glass Lens



ACCU-SYNC® 2018R & 2521R DOT SIGHTS



ACCU-SYNC® 2018R [NEW]
Manual Brightness
Mini ACOG® Footprint / Red 3 MOA / OP-DS2018R



ACCU-SYNC® 2521R
Manual Brightness
Mini ACOG® Footprint / Red 3 MOA / OP-DS2521R



ACCU-SYNC® 2018R & 2521R DOT SIGHTS

- » Precision Machined from 6061-T6 Aluminum and Finished in a Matte Black Anodization
- » Wide Field of View Lens Diameter
- » Impact Resistant Tempered Glass Lens
- » 3 MOA Red Dot with 8 Brightness Settings
- » 30,000+ Hours Battery Life at Middle Brightness Setting
- » Snag-free Flush Turrets with Crisp 1 MOA Per Click Adjustment at 100 Yards
- » IPX7 Waterproof Rated
- » Low Profile Quick Release (QR) Mini ACOG® Mount with Lower 1/3 Co-witness Riser Included

	OP-DS2018R	OP-DS2521R
Lens Diameter	0.75" / 19 mm	0.79" / 20 mm
Reticle / Illumination	Red 3 MOA Dot	Red 3 MOA Dot
Illumination Mode	Manual, 8 Settings	Manual, 8 Settings
Adjustment	1 MOA Per Click	1 MOA Per Click
Material	Anodized AL6061	Anodized AL6061
Battery Type	CR2032 3V	CR2032 3V
Battery Life	30,000+ hrs	30,000+ hrs
Mount Footprint	Mini ACOG®, with Lower 1/3 Co-witness Riser	
Length x Width	2.24" X 1.64"	2.66" X 1.66"
Weight (w/Battery)	5.4 oz	6.1 oz



OP3 MICRO MRDS



OP3 MINI MICRO

Constant-on Automatic Brightness

SHIELD RMSC Footprint / Red 3 MOA / OT-RDM16R

OP3 MINI MICRO MRDS

- » High Clarity Coated Glass Lens Housed within a Precision Machined Matte Black Anodized 6061-T6 Aluminum Body
- » IPX7 Waterproof Rated
- » Lower 1/3 Co-witness with Most Standard Height Iron Sights
- » Integral Rear Backup Iron Sight Milled into Body
- » Protective Optic Cover Included
- » Out-of-the-box Compatible with SIG P365X/XL, GLOCK 43X/48 MOS, WALTHER PPS M2 RMSC, SPRINGFIELD ARMORY HELLCAT OSP, RUGER MAX-9, S&W PERFORMANCE CENTER M&P SHIELD M2.0, and Most Other Optics-Ready Pistol Platforms

	OT-RDM16R
Lens Diameter	0.85" X 0.59"
Reticle / Illumination	Red 3 MOA Dot
Illumination Mode	Automatic, Constant-on
Material	Anodized AL6061
Battery Type	CR2032
Battery Life	30,000+ hrs
Mount Footprint	SHIELD RMSC
Length x Width	1.60" X 0.95"
Weight (w/Battery)	0.70 oz



OP3 MICRO
Manual Brightness

- DOCTER® Footprint / Red 4 MOA / OP-RDM20R
- DOCTER® Footprint / Green 4 MOA / OP-RDM20G
- RMR® Footprint / Red 4 MOA / OP-RMR20R



OP3 MICRO SL

Side Loading Battery / Manual Brightness

- DOCTER® Footprint / Red 4 MOA / OP-RDM20CT



OP3 MICRO SLS

Side Loading Battery / Manual & Auto Sensing Brightness

- DOCTER® Footprint / Red 4 MOA / OP-RDM20CTS
- RMR® Footprint / Red 4 MOA / OP-RMR20CTS

OP3 MICRO MRDS

- » IPX7 Waterproof Rated
- » Coated Wide 23mm FOV Glass Lens
- » Co-witnesses with Most Suppressor Height Iron Sights
- » Tertiary Aiming Point Laser Engraved on Rear Face of Housing

	OP-RDM20R	OP-RDM20G	OP-RMR20R	OP-RDM20CT	OP-RDM20CTS	OP-RMR20CTS
Lens Diameter	0.89" X 0.68"	0.89" X 0.68"	0.89" X 0.68"	0.89" X 0.68"	0.89" X 0.68"	0.89" X 0.68"
Reticle / Illumination	Red 4 MOA Dot	Green 4 MOA Dot	Red 4 MOA Dot	Red 4 MOA Dot	Red 4 MOA Dot	Red 4 MOA Dot
Illumination Mode	Manual	Manual	Manual	Manual	Manual / Automatic	Manual / Automatic
Adjustment	1 MOA Per Click	1 MOA Per Click	1 MOA Per Click	1 MOA Per Click	1 MOA Per Click	1 MOA Per Click
Material	Anodized AL6061	Anodized AL6061	Anodized AL6061	Anodized AL6061	Anodized AL6061	Anodized AL6061
Battery Type	CR2032 3V	CR2032 3V	CR2032 3V	CR1632 3V	CR1632 3V	CR1632 3V
Battery Life	55,000+ hrs	20,000+ hrs	55,000+ hrs	15,000+ hrs	15,000+ hrs	15,000+ hrs
Mount Footprint	Docter®	Docter®	RMR®	Docter®	Docter®	RMR®
Length x Width	1.90" X 1.14"	1.90" X 1.14"	1.78" X 1.14"	1.90" X 1.14"	1.90" X 1.14"	1.78" X 1.14"
Weight (w/Battery)	1.2 oz	1.2 oz	1.1 oz	1.2 oz	1.2 oz	1.2 oz



ITA DOT SIGHTS & MAGNIFIER



3X QD FLIP-TO-SIDE MAGNIFIER

- » Windage/Elevation Adjustability for Optimum View Centering
- » 42mm Center Height for Most Common Dot Sight Combination
- » Perfect Match with: SCP-DS3840W, SCP-DS3039W, SCP-DS3840TDQ
- » Match with 0.60" Riser: SCP-RD40RGW-A
- » Match with 0.75" Riser: SCP-RG40SDQ, SCP-RG40CDQ
- » US PAT. 8397421, US PAT. D672839, EU PAT. EP1984576-0001

Integral QD Mount / SCP-MF3WEQS



» Bidirectional Offset Mount Included

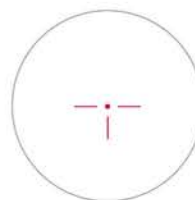

6.0" ITA DOT SIGHT

- » Built on TRUE STRENGTH® Platform
- » Unlimited Eye Relief and Intuitive, Quick-to-Acquire Red/Green T-dot Reticle for Swift Execution of T-Zone and Center Mass Hits
- » Premium Zero Lockable and Zero Resettable Target Turrets with Most Consistent, Precise and Reliable 1/2 MOA per Click Adjustment and Zero Hold Capability
- » 42mm Center Height for 1/3 Co-witness of Front and Rear Iron Sights
- » US PAT. 8397421

RG T-Dot / Bidirectional QD Mount / SCP-TDTDQ





» Offset Riser Applications



4.2" ITA DOT SIGHTS

» US PAT. 8397421

- RG 4 MOA Single Dot / Adjustable Riser / SCP-DS3840W
- RG T-Dot / Adjustable Riser / SCP-DS3840TDQ

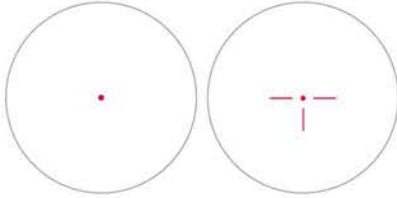

» Offset Riser Applications



3.9" ITA DOT SIGHT

» US PAT. 8397421

- RG 4 MOA Single Dot / Adjustable Riser / SCP-DS3039W

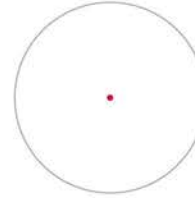

3.8" ITA DOT SIGHTS

» US PAT. 8397421

- RG 4 MOA Single Dot / Integral Mount / SCP-RD40RGW-A
- RG Circle Dot / Integral QD Mount / SCP-RG40CDQ

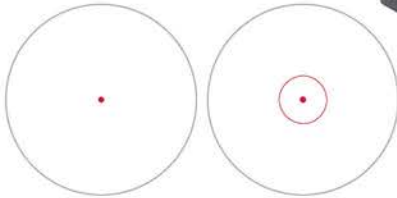

2.6" ITA DOT SIGHT

» US PAT. 8397421

- RG 4 MOA Single Dot / Integral QD Mount / SCP-DS3026W

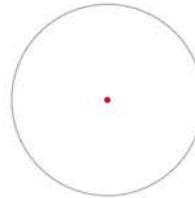

	SCP-MF3WEQS	SCP-TDQ	SCP-DS3840W	SCP-DS3840TDQ	SCP-DS3039W	SCP-RD40RGW-A	SCP-RG40CDQ	SCP-DS3026W
Reticle / Illumination	N/A	T-DOT / RG	Single Dot / RG	T-DOT / RG	Single Dot / RG	Single Dot / RG	Circle Dot / RG	Single Dot / RG
Magnification	3X	1X	1X	1X	1X	1X	1X	1X
Main Tube Diameter	44 mm	38 mm	38 mm	38 mm	30 mm	38 mm	38 mm	30 mm
Objective Diameter	25 mm	39 mm	32 mm	32 mm	26 mm	30 mm	30 mm	21 mm
FOV @ 100 Yards	45'	85'	103'	103'	75'	95'	95'	95'
Eye Relief	2"	Unlimited	Unlimited	Unlimited	Unlimited	Unlimited	Unlimited	Unlimited
Exit Pupil	8.7 mm	Unlimited	Unlimited	Unlimited	Unlimited	Unlimited	Unlimited	Unlimited
Click Value	N/A	1/2"	1/2"	1/2"	1/2"	1/2"	1/2"	1/2"
Center Height	42 mm	42 mm	32 mm (42 mm w/riser)	32mm (42mm w/riser)	30 mm (40 mm w/riser)	25.5 mm	25.5 mm	25 mm
Length	4"	6"	4.2"	4.2"	3.9"	3.8"	3.8"	2.6"
Weight	11.82 oz	13.1 oz	8.7 oz	8.7 oz	8.3 oz	9.4 oz	8.4 oz	4.9 oz
Battery Type	N/A	CR1620 3V	CR1620 3V	CR1620 3V	CR1620 3V	CR2032 3V	CR2032 3V	CR1620 3V

OPTIC MOUNTS & RINGS

A close-up photograph of a metal optic mount assembly mounted on a rifle receiver. The mount is silver-colored and features a large, textured black knob on the right side. A metal rod or tube extends from the left side of the mount. The background is dark and out of focus, showing parts of the rifle's receiver and a wooden stock.

WHAT IT TAKES TO STAY ZEROED.

Staying zeroed. There is more to it than simply torquing down screws or throwing a lever to the side. Surface interfaces must adhere to strict tolerances, thread engagement must be precise to prevent cross-threading, mounts must be square, and locking lugs must be able to return to zero and manage the recoil. Leapers optic mounts & rings check all the boxes with our selection of adaptors, drilled and tapped receiver mounts, scope rings and integral mounts, and more.



JUMP TO A SERIES

SCOPE RINGS & MOUNTS	072
ACCUSYNC® QR Cantilever Mounts	072
ACCUSYNC® QR Cantilever Mounts w/ MOA Compensation [NEW]	073
ACCUSYNC® QR Scope Rings	075
ACCUSYNC® Cantilever Scope Rings & Mounts	077
ACCUSYNC® Anti-cant Levelers	077
UTG PRO® P.O.I.® Scope Rings	079
UTG® Scope Rings & Mounts	081
DOVETAIL-TO-PICATINNY MOUNTS	082
DRILLED & TAPPED RECEIVER MOUNTS	083
SHOTGUN SIDE SADDLE MOUNTS	083
AK & M1A RECEIVER MOUNTS	084
PICATINNY RISERS	085
DEDICATED OPTIC MOUNTS	086
Picatiny Mounts for DOCTER® / RMR®	
Picatiny Mounts for AIMPOINT® Micro	
Dovetail Mounts for RMR®	
Dovetail Mounts for DOCTER®	

(THIRD PARTY TRADEMARKS MAY BE USED IN THIS CATALOG FOR USER CONVENIENCE TO INDICATE THE FIT OR COMPATIBILITY OF THE APPLICABLE PRODUCT.)





ACCURACY SYNCHRONIZED **ACCU-SYNC**[®] QUICK RELEASE **QR**

ACCU-SYNC[®] QR CANTILEVER RINGS & MOUNTS

UTG[®] ACCU-SYNC[®] scope rings and cantilever mounts. Accuracy Synchronized. Featuring a locking quick release lever mount that is tool-free tension adjustable, shooters simply rotate an adjustment gear to increase or decrease the tension applied by the mount, which in turn, virtually accommodates both in and out-of-spec Picatinny Rails. Tested, validated, and proven to handle up to .338 LAPUA Magnum, adjustments made stay true via full contact Picatinny squared recoil stops and a keyed pin for a set-it-and-forget mode of operation. Stay lightweight, ready, and synchronized with a secure zero hold and return to zero with ACCU-SYNC[®] QR.

FULL CONTACT RECOIL STOPS

Rated for .338 Lapua magnum, squared recoil stops prevent forward and rearward movement under harsh recoil



LOCKING QUICK RELEASE LEVERS

QR throw levers lock in place preventing inadvertent release from environmental obstruction



TOOL-FREE & WIDE-RANGE TENSION ADJUSTMENT

Set tension once and adjustment stays locked in, accommodates even most out-of-spec Picatinny rails and provides a secure repeatable zero

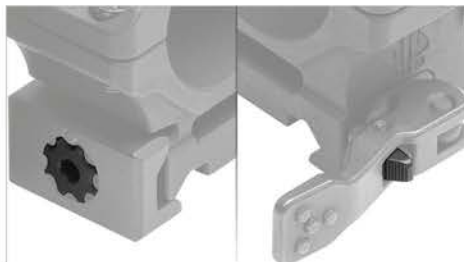

"OUNCES EQUAL POUNDS, POUNDS EQUAL PAIN"

Lightweight skeletonized aluminum construction saves weight where it counts



ACCU-SYNC® CANTILEVER MOUNTS

- » Precision CNC Machined from 6061-T6 Aluminum and Finished in a Matte Black Anodization
- » Quick Release (QR) Mount Features Tool-free Tension Adjustment, Locking QR Levers, and squared Recoil Stops for a Secure Zero Hold and Return to Zero
- » Squared Recoil Stops Prevent Forward and Rearward Movement under Recoil
- » Accommodates Even Most Out-of-spec Picatinny Rails
- » Locking Quick Release Throw Levers Prevent Inadvertent Release
- » Snag-free Radiused Edges and Corners and Melted Contours
- » Lightening Cut for Reduced Weight
- » Rated for .338 LAPUA Magnum



ACCU-SYNC® QR CANTILEVER MOUNTS

MEDIUM PROFILE

1 inch / AIR11834Q
1 inch / AIR11850Q

HIGH PROFILE

1 inch / AIR12250Q
30 mm / AIR32234Q
30 mm / AIR32250Q

X-HIGH PROFILE

34 mm / AIR42270Q



ACCU-SYNC® QR CANTILEVER MOUNTS W/ MOA COMPENSATION

MOA Vertical Compensation Increases Access to Elevation Adjustment Range

NEW

20 MOA

34 mm / AIR420MOA
30 mm / AIR320MOA

30 MOA

34 mm / AIR430MOA
30 mm / AIR330MOA

40 MOA

34 mm / AIR440MOA
30 mm / AIR340MOA

	AIR11834Q	AIR11850Q	AIR12250Q	AIR32234Q	AIR32250Q	AIR42270Q
Ring Type	QR Picatinny Cantilever Mount					
Ring Diameter	1"	1"	1"	30 mm	30 mm	34 mm
Profile	Medium	Medium	High	High	High	X-High
Max. Scope Outer Dia.	61 mm	61 mm	69 mm	73 mm	73 mm	78 mm
Center Height	31 mm	31 mm	35 mm	37 mm	37 mm	39 mm
Saddle Height	18 mm	18 mm	22 mm	22 mm	22 mm	22 mm
Ring Width	25 mm	25 mm	25 mm	25 mm	25 mm	25 mm
Ring Distance	44 mm	60 mm	60 mm	44 mm	60 mm	60 mm
Integral Base Length	100 mm	100 mm	100 mm	100 mm	100 mm	80 mm
Offset Distance	34 mm	50 mm	50 mm	34 mm	50 mm	70 mm

	AIR420MOA	AIR320MOA	AIR430MOA	AIR330MOA	AIR440MOA	AIR340MOA
Ring Type	QR Picatinny Cantilever Mount with MOA Compensation					
Ring Diameter	34 mm	30 mm	34 mm	30 mm	34 mm	30 mm
MOA	20	20	30	30	40	40
Tilted Degree	0.33°	0.33°	0.50°	0.50°	0.67°	0.67°
Max. Scope Outer Dia.	34 mm	30 mm	34 mm	30 mm	34 mm	30 mm
Center Height	39 mm	37 mm	39 mm	37 mm	39 mm	37 mm
Ring Width	25 mm	25 mm	25 mm	25 mm	25 mm	25 mm
Ring Distance	60 mm	60 mm	60 mm	60 mm	60 mm	60 mm
Integral Base Length	80 mm	80 mm	80 mm	80 mm	80 mm	80 mm
Offset Distance	70 mm	70 mm	70 mm	70 mm	70 mm	70 mm

ACCURACY SYNCHRONIZED QUICK RELEASE
ACCU-SYNC® QR



ACCU-SYNC® QR SCOPE RINGS



LOW PROFILE
1 inch / AQR110
30 mm / AQR310

MEDIUM PROFILE
1 inch / AQR115
30 mm / AQR315
34 mm / AQR415

PICATINNY
HIGH PROFILE
1 inch / AQR120
30 mm / AQR322
34 mm / AQR420

X-HIGH PROFILE
34 mm / AQR422

2X-HIGH PROFILE
34 mm / AQR432

ACCU-SYNC® QR SCOPE RINGS

- » Tool-free and Wide-Range Tension Adjustment
- » Accommodates Even Most Out-of-spec Picatinny Rails
- » Locking Quick Release Throw Levers Prevent Inadvertent Release
- » Rated for .338 LAPUA Magnum
- » Squared Recoil Stops Prevent Forward and Rearward Movement under Recoil
- » Snag-free Radiused Edges and Corners and Melted Contours
- » Lightweight Skeletonized Matte Black Anodized Aluminum Construction

	AQR110	AQR115	AQR120	AQR310	AQR315	AQR322	AQR415	AQR420	AQR422	AQR432
Ring Type	Picatinny Rings (set of 2)									
Ring Diameter	1"	1"	1"	30 mm	30 mm	30 mm	34 mm	34 mm	34 mm	34 mm
Profile	Low	Medium	High	Low	Medium	High	Medium	High	X-High	2X-High
Max. Scope Outer Dia.	45.4 mm	55.4 mm	65.4 mm	50 mm	60 mm	74 mm	64 mm	74 mm	98 mm	98 mm
Center Height	22.7 mm	27.7 mm	32.7 mm	25 mm	30 mm	37 mm	32 mm	37 mm	39 mm	49 mm
Saddle Height	10 mm	15 mm	20 mm	10 mm	15 mm	22 mm	15 mm	20 mm	22 mm	32 mm
Ring Width	22 mm	22 mm	22 mm	22 mm	22 mm	22 mm	22 mm	22 mm	22 mm	22 mm

ACCURACY SYNCHRONIZED
ACCU-SYNC®



ACCU-SYNC® CANTILEVER RINGS & MOUNTS

- » Lightweight Skeletonized Matte Black Anodized Aluminum Construction
- » Accommodates Even Most Out-of-spec Picatinny Rails
- » Locking Quick Release Throw Levers Prevent Inadvertent Release
- » Squared Recoil Stops Prevent Forward and Rearward Movement under Recoil
- » Snag-free Radiused Edges and Corners and Melted Contours
- » Lightening Cuts Reduce Weight Without Compromising Durability



PICATINNY CANTILEVER MOUNTS

MEDIUM PROFILE

- 1 inch / AIR11834
- 1 inch / AIR11850
- 30 mm / AIR31834
- 30 mm / AIR31850

HIGH PROFILE

- 1 inch / AIR12234
- 1 inch / AIR12250
- 30 mm / AIR32234
- 30 mm / AIR32250
- 34 mm / AIR42250



PICATINNY CANTILEVER SCOPE RINGS

HIGH PROFILE

- 1 inch / AIR122S
- 30 mm / AIR322S
- 34 mm / AIR422S

ACCU-SYNC® ANTI-CANT LEVELERS

- » Magnetic Flip-to-Side Anti-Cant Bubble Leveler Easily Seen Through Peripherals without having to Break Target Focus and or Adjust Cheek Weld
- » Durable Matte Black Anodized 6061-T6 Aluminum Construction
- » Compatible with UTG® ACCU-SYNC® Cantilever Mounts and Rings that Feature a Mechanical Offset
- » US PAT. 1129372

ANTI-CANT LEVELERS

- 1 inch / MT-RTR1
- 30 mm / MT-RTR3
- 34 mm / MT-RTR4



ACCU-SYNC® ANTI-CANT LEVELERS & MRDS MOUNTS

- » Includes Cover Plate and DOCTER® and RMR® Footprint Compatible Optic Plates

- 1 inch with MRDS Mounts / MT-RTF1
- 30 mm with MRDS Mounts / MT-RTF3
- 34 mm with MRDS Mounts / MT-RTF4



	AIR11834	AIR11850	AIR12234	AIR12250	AIR31834	AIR31850	AIR32234	AIR32250	AIR42250	AIR122S	AIR322S	AIR422S
Ring Type	Picatinny Cantilever Mount								Cantilever Scope Rings			
Ring Diameter	1"	1"	1"	1"	30 mm	30 mm	30 mm	30 mm	34 mm	1"	30 mm	34 mm
Profile	Medium	Medium	High	High	Medium	Medium	High	High	High	High	High	High
Max. Scope Outer Dia.	61 mm	61 mm	69 mm	69 mm	65 mm	65 mm	73 mm	73 mm	77 mm	69 mm	73 mm	77 mm
Center Height	31 mm	31 mm	35 mm	35 mm	33 mm	33 mm	37 mm	37 mm	39 mm	35 mm	37 mm	39 mm
Saddle Height	18 mm	18 mm	22 mm	22 mm	18 mm	18 mm	22 mm	22 mm	22 mm	22 mm	22 mm	22 mm
Ring Width	25 mm	25 mm	25 mm	25 mm	25 mm	25 mm	25 mm	25 mm	25 mm	25 mm	25 mm	25 mm
Ring Distance	44 mm	60 mm	44 mm	60 mm	44 mm	60 mm	44 mm	60 mm	60 mm	N/A	N/A	N/A
Integral Base Length	100 mm	100 mm	100 mm	100 mm	100 mm	100 mm	100 mm	100 mm	100 mm	32 mm	32 mm	32 mm
Offset Distance	34 mm	50 mm	34 mm	50 mm	34 mm	50 mm	34 mm	50 mm	50 mm	37 mm	37 mm	37 mm

PRECISION OPTICS INTERFACE®



BEFORE HANDLING RIFLE READ MANUAL FROM:

BARRETT

BARRETT FIREARMS MANUFACTURING, INC.
MORRISVILLE, N.C. U.S.A.

82A1
AA002

SAFE



P.O.I.[®] | PRECISION OPTICS INTERFACE | SCOPE RINGS



PICATINNY

LOW PROFILE
1 inch / RWU012510
30 mm / RWU013010

MEDIUM PROFILE
1 inch / RWU012515
30 mm / RWU013015
34 mm / RWU013415

HIGH PROFILE
1 inch / RWU012520
30 mm / RWU013022
34 mm / RWU013420

DOVETAIL

LOW PROFILE
1 inch / RDU013010

MEDIUM PROFILE
1 inch / RDU012515
30 mm / RDU013015

HIGH PROFILE
1 inch / RDU012520
30 mm / RDU013022



P.O.I.[®] | PRECISION OPTICS INTERFACE | SCOPE RINGS

- » Progressively Machined Inner Diameter for a Precise and Seamless Ring-to-Scope Interface
- » Low Profile and Flush-fitting Locking Side Plate Features Dual Spring-loaded Guides Ensuring a Secure and Repeatable Zero
- » Integral Squared Recoil Stops Eliminate Forward and Rearward Movement Under Recoil
- » Rated up to .50 BMG
- » US PAT. D771218, EU PAT. 002761064-0001

	RWU012510	RWU012515	RWU012520	RWU013010	RWU013015	RWU013022	RWU013415	RWU013420	RDU012515	RDU012520	RDU013010	RDU013015	RDU013022
Ring Type	Picatinny Scope Rings (set of 2)								Dovetail Scope Rings (set of 2)				
Ring Diameter	1"	1"	1"	30 mm	30 mm	30 mm	34 mm	34 mm	1"	1"	30 mm	30 mm	30 mm
Profile	Low	Medium	High	Low	Medium	High	Medium	High	Medium	High	Low	Medium	High
Max. Scope Outer Dia.	45 mm	55 mm	65 mm	49 mm	59 mm	73 mm	63 mm	73 mm	55 mm	65 mm	49 mm	59 mm	73 mm
Center Height	23 mm	28 mm	33 mm	25 mm	30 mm	37 mm	32 mm	37 mm	28 mm	33 mm	25 mm	30 mm	37 mm
Saddle Height	10 mm	15 mm	20 mm	10 mm	15 mm	22 mm	15 mm	20 mm	15 mm	20 mm	10 mm	15 mm	22 mm
Ring Width	22 mm	22 mm	22 mm	22 mm	22 mm	22 mm	22 mm	22 mm	22 mm	22 mm	22 mm	22 mm	22 mm



UTG® SCOPE RINGS & MOUNTS



PICATINNY

LOW PROFILE

1 inch / RG2W1104
30 mm / RG2W3104

MEDIUM PROFILE

1 inch / RG2W1154
30 mm / RG2W3154

HIGH PROFILE

1 inch / RG2W1204
30 mm / RG2W3224



LOW PROFILE

1 inch / RGWM-25L2
30 mm / RGWM-30L4

PICATINNY

MEDIUM PROFILE

1 inch / RGWM-25M4
30 mm / RGWM-30M4

HIGH PROFILE

1 inch / RGWM-25H4
30 mm / RGWM-30H4



DOVETAIL

MEDIUM PROFILE

1 inch / RGPM-25M4
30 mm / RGPM-30M4
1 inch / RGPM2PA-25M4
30 mm / RGPM2PA-30M4

HIGH PROFILE

1 inch / RGPM-25H4
30 mm / RGPM-30H4
1 inch / RGPM2PA-25H4
30 mm / RGPM2PA-30H4
1 inch / RGPMOFS38-25H4

	RG2W1104	RG2W1154	RG2W1204	RG2W3104	RG2W3154	RG2W3224
Ring Type	QD Twist Lock Picatinny Scope Rings (set of 2)					
Ring Diameter	1"	1"	1"	30 mm	30 mm	30 mm
Profile	Low	Medium	High	Low	Medium	High
Max. Scope Outer Dia.	45 mm	55 mm	65 mm	49 mm	59 mm	73 mm
Center Height	23 mm	28 mm	33 mm	25 mm	30 mm	37 mm
Saddle Height	10 mm	15 mm	20 mm	10 mm	15 mm	22 mm
Ring Width	18 mm	22 mm	22 mm	22 mm	22 mm	22 mm

	RGWM-25L2	RGWM-25M4	RGWM-25H4	RGWM-30L4	RGWM-30M4	RGWM-30H4
Ring Type	Picatinny Scope Rings (set of 2)					
Ring Diameter	1"	1"	1"	30 mm	30 mm	30 mm
Profile	Low	Medium	High	Low	Medium	High
Max. Scope Outer Dia.	45 mm	53 mm	61 mm	47 mm	57 mm	73 mm
Center Height	23 mm	27 mm	31 mm	24 mm	29 mm	37 mm
Saddle Height	10 mm	14 mm	18 mm	9 mm	14 mm	22 mm
Ring Width	16 mm	21 mm	21 mm	21 mm	21 mm	21 mm

	RGPM-25M4	RGPM-25H4	RGPM-30M4	RGPM-30H4	RGPM2PA-25M4	RGPM2PA-25H4	RGPM2PA-30M4	RGPM2PA-30H4	RGPMOFS38-25H4
Ring Type	Dovetail Scope Rings (set of 2)				Dovetail Scope Ring Mounts				
Ring Diameter	1"	1"	30 mm	30 mm	1"	1"	30 mm	30 mm	1"
Profile	Medium	High	Medium	High	Medium	High	Medium	High	High
Max. Scope Outer Dia.	53 mm	67 mm	57 mm	71 mm	53 mm	67 mm	57 mm	71 mm	67 mm
Center Height	27 mm	34 mm	29 mm	36 mm	27 mm	34 mm	29 mm	36 mm	34 mm
Saddle Height	14 mm	21 mm	14 mm	21 mm	14 mm	21 mm	14 mm	21 mm	21 mm
Ring Width	21 mm	21 mm	21 mm	21 mm	21 mm	21 mm	21 mm	21 mm	21 mm
Ring Distance	N/A	N/A	N/A	N/A	58 mm	58 mm	58 mm	58 mm	39 mm
Integral Base Length	N/A	N/A	N/A	N/A	100 mm	100 mm	100 mm	100 mm	62 mm
Offset Distance	N/A	N/A	N/A	N/A	N/A	N/A	N/A	N/A	38 mm



DOVETAIL TO PICATINNY MOUNTS



DOVETAIL TO PICATINNY ADAPTOR MOUNT

- » Precision Machined from Aircraft Aluminum with a Matte Black Finish
- » 3.94" Scalloped 9 Slot Picatinny Rail with 0.59" Saddle Height
- » Compatible with Flat Receivers Equipped with 9mm-11mm Dovetail Rails
- » US PAT. D837330

/ MNT-PMTOWL-A



UNIVERSAL DOVETAIL TO PICATINNY ADAPTOR

- » Precision Machined from Aircraft Aluminum with a Matte Black Finish
- » Compatible with 9mm - 11mm Flat or Rounded Dovetail Rails
- » US PAT. 10352656, EU PAT. EP3196588

/ MNT-DTW145



DOVETAIL-TO-PICATINNY SNAP-IN RAIL ADAPTOR

- » Converts Picatinny Mounts and Accessories to Dovetail
- » Spring-loaded Self-adjusting Width with Removable Stop Pin for Added Retention
- » Reliable Aluminum and Steel Construction
- » US PAT. 8752325, EU PAT. EP3196588

/ MNT-DT2PW01 (Set Of 2)

DRILLED & TAPPED RECEIVER MOUNTS



UTG PRO

OPTIC MOUNT FOR REMINGTON® 870™

- » Precision Machined from Aircraft Aluminum with a Matte Black Hard Coat Anodize
- » 6.1" Length with 14 Picatinny Slots
- » Low Profile with See Thru Design for Use of Front Bead Sight
- » Compatible with REMINGTON® 870™/1100™ with Drilled and Tapped Receiver

/ MTU028SG



OPTIC MOUNT FOR REMINGTON® 700®

- » Solid Steel Construction
- » Clearance Cut for Reliable Case Ejection

For REMINGTON® 700® Long Action Rifles / MNT-RM700

For REMINGTON® 700® Short Action Rifles / MNT-RM700S



UTG PRO

OPTIC MOUNT FOR MOSSBERG® 500®

- » Precision Machined from Aircraft Aluminum with a Matte Black Hard Coat Anodize
- » 5.5" Length with 13 Picatinny Slots
- » Low Profile See Thru Design Allows Use of Front Sight Bead
- » Compatible with MOSSBERG® Model 500® with Drilled and Tapped Receiver

/ MTU029SG



UTG PRO

OPTIC MOUNT FOR RUGER® 10/22®

- » Precision Machined from Aircraft Aluminum with a Matte Black Hard Coat Anodize
- » 4.67" Length with 11 Picatinny Slots
- » Low Profile Design with U-cut for Weight Reduction
- » Compatible with RUGER® 10/22® with Drilled and Tapped Receiver

/ MTU030T22

SHOTGUN SIDE SADDLE MOUNTS



OPTIC MOUNT FOR MOSSBERG® 500® / 590® / 590M®

- » Durable 6061-T6 Aluminum Construction Finished in a Matte Black Anodization
- » Removable 4-Capacity Shot Shell Carrier Included
- » MT-MB590: Compatible with 12 Gauge MOSSBERG® 500®/590® Shotguns
- » MT-MB590M: Compatible with 12 Gauge MOSSBERG® 590M® Mag-Fed Shotguns

For MOSSBERG® 500® / 590® / MT-MB590

For MOSSBERG® 590M® / MT-MB590M



OPTIC MOUNT FOR REMINGTON® 870™

- » Durable 6061-T6 Aluminum Construction Finished in a Matte Black Anodization
- » Removable 4-Capacity Shot Shell Carrier Included
- » Compatible with 12 Gauge REMINGTON® 870™ and 870 DM Shotguns with up to a 3.5" Chambering

/ MT-RM870



AK & M1A RECEIVER MOUNTS



ACCU-SYNC® QR AK SIDE MOUNT

- » Matte Black Anodized Steel-reinforced 6061-T6 Aluminum Construction
- » Tool-free, Tension-adjustable Quick Release (QR) Lever Mount Compatible with Most Standard Receiver Side Rails
- » Universal, 16-slot Picatinny Top Rail, Centering with Receiver May Vary Depending on Rifle Make and Model and Manufacturer Tolerances
- » Overall Lightweight Design Features 2 Side M-LOK® Slots for Attaching Accessories
- » US PAT. D949276, US PAT. D949277

/ MT-UAK01



UTG PRO®

AK QD SIDE MOUNT

- » Proudly Designed and Made in USA
- » Matte Black Anodized 6061-T6 Aluminum Construction
- » Lightweight Design with Deep U-Cut Channel for Accessing Iron Sights
- » 16 Slot Picatinny Top Rail with Detachable 6 Slot Side Rail
- » Adjustable Quick Detach Lever Mount

/ MTU016



AK QD SIDE MOUNT FOR ZASTAVA M70 N-PAP

- » Matte Black Anodized 6061-T6 Aluminum Construction
- » Adjustable Quick-detach Lever Mount
- » Scalloped 15 Slot Picatinny Rail Features a Deep U-cut Channel for Accessing Iron Sights
- » Overall Lightweight Design Features 2 Side M-LOK® Slots for Attaching Accessories
- » US PAT. D949276, US PAT. D949277

/ MT-ZAK01



AK STEEL SIDE PLATE

- » Durable Steel Construction with a Matte Black Finish
- » Fits Both Milled and Stamped AK Receivers and Accepts a Wide Variety of Side Optic Mounts
- » Permanent Modification Required

/ TL-M47SR



OPTIC MOUNT FOR M14/M1A

- » Full-length 15 Slot Scalloped Picatinny Top Rail
- » Iron Sight Accessible Channel
- » Secure Zero Retention through 4 Points of Contact with Receiver
- » Matte Black Anodized Aluminum Construction
- » No Permanent Modification Required

/ MNT-914V2

PICATINNY RISERS



PICATINNY RISER MOUNTS

0.5 INCH

3-slot / MT-RSX5S
13-slot / MT-RSX5L

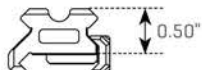

US PAT. D784482

0.75 INCH

3-slot / MT-RSX7S
13-slot / MT-RSX7L

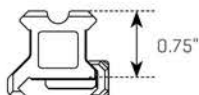

US PAT. D784483

0.83 INCH

3-slot / MT-RSX8S
13-slot / MT-RSX8L

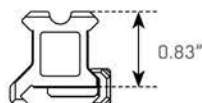

1 INCH

3-slot / MT-RSX1S
13-slot / MT-RSX1L

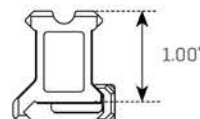

US PAT. D784481

20 MOA ELEVATED PICATINNY MOUNT

13-slot / MT-RSX20MOA



SUPER SLIM PICATINNY RISER MOUNTS

- » Matte Black Anodized 6061-T6 Aluminum Construction
- » Lightweight and Low Profile with Dehorned Corners and Melted Contours
- » Laser Engraved T-marked MIL-STD-1913 Picatinny Rail
- » Squared Recoil Stops for a Secure and Repeatable Zero Hold
- » Lightening Cuts Reduce Overall Weight and Bulk (Medium and High Profile Only)

	MT-RSX5S	MT-RSX7S	MT-RSX8S	MT-RSX1S	MT-RSX5L	MT-RSX7L	MT-RSX8L	MT-RSX1L	MT-RSX20MOA
Length	1.6"	1.6"	1.6"	1.6"	5.5"	5.5"	5.5"	5.5"	5.5"
Saddle Height	0.50"	0.75"	0.83"	1.00"	0.50"	0.75"	0.83"	1.00"	0.52"/0.55"
Picatinny Slots	3	3	3	3	13	13	13	13	13
Weight	0.9 oz	0.9 oz	1.0 oz	1.0 oz	2.7 oz	2.7 oz	2.8 oz	2.8 oz	2.7 oz



Utilizes Locking Torx Screws and Squared Recoil Stops for a Secure Zero Hold

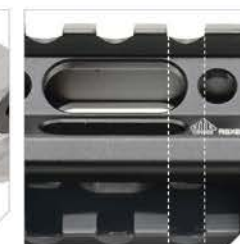

Rail Slots Index in Line with Receiver Slots

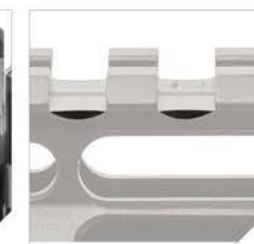

Scalloped Picatinny Slots for Snag Free Accessory Mounting



DEDICATED PICATINNY OPTIC MOUNTS

FOR DOCTER® / RMR®



45 DEGREE

DOCTER® Footprint / RDM-2045
RMR® Footprint / MT-RMR45



LOW PROFILE

RMR® Footprint / MT-RMRXS



ABSOLUTE CO-WITNESS

DOCTER® Footprint / RDM-20AC
RMR® Footprint / MT-RMRAC



LOWER 1/3 CO-WITNESS

RMR® Footprint / MT-RMR13C



FOR AIMPOINT® MICRO

LOWER 1/3 & ABSOLUTE CO-WITNESS

Lower 1/3 Co-Witness / MT-T113C
Absolute Co-Witness / MT-T1AC

	RDM-2045	RDM-20AC	MT-RMR45	MT-RMR13C	MT-RMRKIT		MT-T1AC	MT-T113C
					MT-RMRAC	MT-RMRXS		
Footprint	For DOCTER®	For DOCTER®	For TRIJICON RMR®	For TRIJICON RMR®	For TRIJICON RMR®	For TRIJICON RMR®	For AIMPOINT® Micro	For AIMPOINT® Micro
Length / Width	1.8" / 2.5"	1.8" / 1.1"	1.8" / 2.5"	1.8" / 1.1"	1.8" / 1.1"	1.8" / 1.1"	1.9" / 1.2"	1.9" / 1.2"
Saddle Height	N/A	0.78"	N/A	0.95"	0.87"	0.40"	0.78"	1.04"
Weight	1.5 oz	1.5 oz	1.4 oz	1.6 oz	1.5 oz	1.4 oz	1.2 oz	1.3 oz



DEDICATED DOVETAIL OPTIC MOUNTS

FOR RMR®



REAR SIGHT DOVETAIL

For GLOCK® Dovetail / MT-RMRGL

FOR DOCTER®



REAR SIGHT DOVETAIL

For GLOCK® Dovetail / RDM-20GL
For Sig P-Series Dovetail / RDM-20SIG
For S&W M&P® Dovetail / RDM-20SW



LOW PROFILE

0.33" Saddle Height / RDM-20XSD

OP3 MICRO MRDS

* Refer to P. 066 - P. 067 for More Info



OP3 MICRO SL

Side Loading Battery / Manual Brightness

DOCTER® Footprint / Red 4 MOA / OP-RDM20CT

OP3 MICRO SLS

Side Loading Battery / Manual & Auto Sensing Brightness

DOCTER® Footprint / Red 4 MOA / OP-RDM20CTS

RMR® Footprint / Red 4 MOA / OP-RMR20CTS

OP3 MICRO

Manual Brightness

DOCTER® Footprint / Red 4 MOA / OP-RDM20R

DOCTER® Footprint / Green 4 MOA / OP-RDM20G

RMR® Footprint / Red 4 MOA / OP-RMR20R

	MT-RMRGL	RDM-20GL	RDM-20SIG	RDM-20SW	RDM-20XSD
Mount Type	For GLOCK® Dovetail	For GLOCK® Dovetail	For SIG P-Series Dovetail	For S&W M&P® Dovetail	9mm - 11mm Flat or Round Dovetail
Footprint	For TRIJICON RMR®	For DOCTER®	For DOCTER®	For DOCTER®	For DOCTER®
Length / Width	1.8" / 1.1"	1.8" / 1.1"	1.8" / 1.1"	1.8" / 1.1"	1.8" / 1.1"
Saddle Height	0.16"	0.15"	0.16"	0.16"	0.3"
Weight	0.4 oz	0.5 oz	0.5 oz	0.5 oz	21.3 oz

PERIODIC.COM | SINCE 1992

A close-up photograph of a man wearing a grey tactical helmet and clear safety glasses, aiming a black rifle. He is looking through the iron sights of the rifle. The rifle has a black handguard with a Picatinny rail. The man is wearing a grey t-shirt and a black watch on his left wrist. The background is a plain, light-colored wall.

IRON SIGHTS

TRIED AND TRUE.

Irons still have their place. Primary and even secondary optics aside, iron sights remain an effective means of getting shots on target despite being more of a tertiary redundancy today. Leapers iron sights are intuitive, minimalistic, and available in different configurations. Your backup has arrived.



JUMP TO A SERIES

AR FLIP-UP SIGHTS	090
UTG PRO® Flip-Up Sights	091
UTG® ACCU-SYNC® 45° Flip-Up Sights	092
UTG® Super Slim Flip-Up Sights	093
UTG® ACCU-SYNC® Spring-Loaded Flip-Up Sights	093
AR FIXED SIGHTS	094
Carry Handles	094
Super Slim Fixed Sights	095

[THIRD PARTY TRADEMARKS MAY BE USED IN THIS CATALOG FOR USER CONVENIENCE TO INDICATE THE FIT OR COMPATIBILITY OF THE APPLICABLE PRODUCT.]





 **UTG[®]**
PRO

UTG PRO® FLIP-UP SIGHTS



FRONT SIGHT / TLUFS55
 » Utilizes Standard Elevation Adjustable A2 Front Sight Post



REAR SIGHT / TLURS55
 » Dual Aperture Tool-free Windage Adjustment



UTG PRO®

AR15 FLIP-UP FRONT & REAR SIGHTS

- » Proudly Designed and Made in USA
- » Durable Aircraft Aluminum Construction with Reinforced Steel Components
- » Finished in a Durable Matte Black Anodization
- » Designed for the AR Platform and Fits Most Picatinny Rails
- » Manual Flip-up Sight Tower Locks into Place when Deployed, Unlocks via Spring-loaded Push Button

	TLUFS55	TLURS55
Position	Front	Rear
Adjustment	Standard Elevation Adjustable A2 Front Sight Post	Dual Aperture Tool-free Windage Adjustment
Stowed Height	0.55"	0.55"
Weight	1.3 oz	1.52 oz



AR FLIP-UP SIGHTS



ACCU-SYNC® 45° FLIP-UP FRONT & REAR SIGHTS

- » Durable Aircraft Aluminum Construction with Reinforced Steel Components
- » Finished in a Durable Matte Black Anodization
- » 45° Angled Offset Allows Access to Iron Sights Simultaneously with Magnified Optics
- » Posi-lock Retention Plunger Locks Sight in Deployed Position
- » Utilizes a Single Locking Torx Screw and Squared Recoil Stops for a Secure Zero Hold and Return to Zero on Picatinny Rails

FRONT SIGHT / MT-745

- » Tool-free Front Sight Post Elevation Adjustment Wheel
- » US PAT. 10030935, US PAT. D851203

REAR SIGHT / MT-945

- » Dual Aperture Rear Sight with Tool-free Windage Adjustment Wheel
- » US PAT. 10030935, US PAT. D852920



Posi-lock Retention Detent



45° Angled Offset

AR FLIP-UP SIGHTS



SUPER SLIM FLIP-UP FRONT & REAR SIGHTS

- » Durable Aircraft Aluminum Construction with Reinforced Steel Components
- » Finished in a Durable Matte Black Anodization
- » Posi-lock Design with Side Plunger Release Prevents Sight Tower from Collapsing when Deployed
- » Low Profile 3mm Locking Bolt and Mounting Deck Securely Attaches to any Picatinny Rail, 0.55" Stowed Height

FRONT SIGHT / MNT-755

- » Standard A2 Front Sight Post with Precise Elevation Adjustment

REAR SIGHT / MNT-955

- » Dual Aperture Rear Sight with Tool-free Windage Adjustment Wheel



ACCU-SYNC® SPRING-LOADED FLIP-UP FRONT & REAR SIGHTS

- » Durable Aircraft Aluminum Construction with Reinforced Steel Components
- » Finished in a Durable Matte Black Anodization
- » Posi-lock Push Button Automatically Deploys the Spring Loaded Sight and Prevents Sight from Collapsing when Deployed
- » Utilizes a Single Locking Torx Screw and Squared Recoil Stops for a Secure Zero Hold and Return to Zero on Picatinny Rails
- » Lightweight, Space Saving, Fold Over Design Uses Minimal Rail Space, 0.6" Stowed Height

FRONT SIGHT / MNT-757

- » Uses Standard A2 Front Sight Post, Interchangeable with Other Aftermarket Posts with Equivalent Dimensions
- » US PAT. 10119784, US PAT. D863490

REAR SIGHT / MNT-957

- » Dual Aperture Rear Sight with Tool-free Windage Adjustment Wheel
- » US PAT. 10119784, US PAT. D863489

	MT-745	MT-945	MNT-755	MNT-955	MNT-757	MNT-957
Position	Front	Rear	Front	Rear	Front	Rear
Adjustment	Integrated Elevation Adjustment Wheel Provides Tool-free Front Sight Post Adjustment	Windage Adjustment Wheel Provides Tool-free Adjustment of the Dual Aperture Sight	Standard Elevation Adjustable A2 Front Sight Post	Dual Aperture Tool-free Windage Adjustment	Uses Standard A2 Front Sight Post, Interchangeable with Other Aftermarket Posts with Equivalent Dimensions	Tool-free Windage Adjustment and Dual Apertures Ideal for a Variety of Different Scenarios
Stowed Height	-	-	0.55"	0.55"	0.63"	0.63"
Weight	1.10 oz	1.10 oz	1.3 oz	1.52 oz	1.20 oz	1.40 oz



CARRY HANDLES



UTG PRO® 

FORGED 7075-T6 ALUMINUM

MIL-SPEC FORGED CARRY HANDLE SIGHT

- » Mil-spec Match Grade Detachable Carry Handle with A2 Sight Assembly
- » Picatinny Mounting Base with Full Length Locking Plate and Dual Oversized Locking Thumb Wheels
- » Forged 7075-T6 Aluminum and Steel Construction Finished in a Matte Black Finish
- » Steel A2 Sight Assembly Provides Precise and Reliable Windage/Elevation Adjustment, Complete with Dual Aiming Apertures
- » Compatible with in-line Rail Mounted Front Sights and Taller F-marked Front Sight Bases

/ TLURS001



ENHANCED CARRY HANDLE REAR SIGHT

- » Matte Black Anodized CNC Machined 6061-T6 Aluminum and Steel Construction
- » Staked and Knurled Thumb Wheels Can Be Tightened by Hand in the Field or by a Flathead Screw Driver or M6 Hex Wrench
- » A2 Dual Aperture and 6/3 Windage Drum
- » MIL-STD-1913 Picatinny Compatible Squared Recoil Lugs for A Secure Zero Hold and Return to Zero
- » Compatible with In-line Rail Mounted Front Sights and Taller F-marked Front Sight Bases

/ MT-950X

AR FIXED SIGHTS



LOW PROFILE SUPER SLIM FRONT SIGHT

- » Low Profile Front Sight with Adjustable A2 Front Sight Post, Fits on Picatinny Handguard or High Profile Gas Block Levelled with Flat Top Upper Receiver
- » Utilizes a Locking Torx Screw Side Plate and Squared Recoil Stop to Ensure a Secure Zero Hold and Return to Zero on MIL-STD-1913 Picatinny Rails
- » CNC Machined 6061-T6 Aircraft Aluminum and Steel Construction with a Matte Black Finish

/ MT-754X



HIGH PROFILE SUPER SLIM FRONT SIGHT

- » High Profile Front Sight with Adjustable A2 Front Sight Post, Fits Lowered Offset Picatinny Railed Gas Blocks
- » Utilizes a Locking Torx Screw Side Plate and Squared Recoil Stop to Ensure a Secure Zero Hold and Return to Zero on MIL-STD-1913 Picatinny Rails
- » CNC Machined 6061-T6 Aircraft Aluminum and Steel Construction with a Matte Black Finish

/ MT-750X



SUPER SLIM REAR SIGHT

- » Precision CNC Machined 6061-T6 Aircraft Aluminum Base with Steel A2 Sight Assembly
- » Slim and Lightweight Profile with a Durable Wear Resistant Matte Black Finish
- » Tool-free Windage and Elevation Adjustment with Dual Apertures
- » Utilizes a Single Locking Torx Screw and Squared Recoil Stop for a Secure Zero Hold and Return to Zero on MIL-STD-1913 Picatinny Rails

/ MT-950RS03



AR15 CARRY HANDLE RAIL MOUNT

- » Top Rail with 12 Scalloped Picatinny Slots and Secondary Integral STANAG Mounting Base
- » CNC Machined 6061-T6 Aircraft Aluminum and Steel Construction with a Matte Black Finish
- » Iron Sight Accessible
- » Secured Via Locking Knurled Thumb Nut

/ MNT-993



RECEIVERS

**MICHIGAN MADE.
UNCOMPROMISING STANDARDS.**

Michigan made and designed from the ground up to provide shooters with functionality that benefits their skill set. UTG PRO® billet 7075-T6 receivers feature shooter-focused ergonomics, rigid reliability, common parts compatibility, and a lightweight overall design perfect for the basis of your next build.



JUMP TO A SERIES

UTG PRO® AR15 AMBI BILLET RECEIVERS **[NEW]** 101

AR15 Billet Upper Receiver

AR15 Ambi Billet Lower Receiver

AR15 Ambi Billet Receiver Set

UTG PRO® AR15 BILLET RECEIVERS **[NEW]** 103

AR15 Billet Upper Receiver

AR15 Billet Lower Receiver

AR15 Billet Receiver Set

(THIRD PARTY TRADEMARKS MAY BE USED IN THIS CATALOG FOR USER CONVENIENCE TO INDICATE THE FIT OR COMPATIBILITY OF THE APPLICABLE PRODUCT.)





SHOOTER DRIVEN. TRULY AMBI.

What does a standard forged mil-spec AR do well and is there room for true improvement when functionality, ergonomics, and cosmetics come into play? UTG PRO[®] AR receivers, influenced by the professional, competition, and rightful civilian alike, are enhanced AR receivers driven by shooters and made for you.



UTG PRO[®]

PROUDLY MADE IN USA

AR15 AMBI BILLET RECEIVER

7075-T6 ALUMINUM | TYPE III CLASS II HARDCOAT ANODIZED

TRUE
MGI

 UTC
PRO

AR15 AMBI BILLET RECEIVERS



UTG PRO  **NEW**

AR15 AMBI BILLET RECEIVERS

- » Proudly Designed and Made in USA
- » True Ambidextrous Lower with Left and Right Side Magazine Release and Bolt Hold-open and Release
- » Matte Black Type III Class II Hard Coat Anodized 7075-T6 Billet Construction
- » Glove-friendly Oversized Trigger Guard
- » Fenced-in Magazine Releases and Ambidextrous Trigger Finger Indexing Points
- » Shortened and Flared Magwell Fully Compatible with Most Magazines and Drums
- » Threaded Steel Retention Pins and Set Screws, Zero Roll Pins Used in Assembly
- » Optional Receiver Tensioning Screw Included
- » Compatible with Most Furniture, Fire Control Groups, Bolt Carrier Groups, and Parts Kits
- » Captured Buffer and Rear Takedown Pin Detent and Spring
- » Tight Tolerance Fit of Upper and Lower Receiver, Takedown and Pivot Pins, and Barrel Extension
- » Upper Receiver Cut for M4 Feed Ramps
- » Upper Receiver Flattop Features an Additional Picatinny Slot
- » Multi-caliber Marked

AR15 BILLET UPPER RECEIVER / FUR001
AR15 AMBI BILLET LOWER RECEIVER / FLR002
AR15 AMBI BILLET RECEIVER SET / FCR02



True Ambi Lower with
Right Side Bolt Hold
Open and Release



Threaded Steel
Retention Pins and Set
Screws, Zero Roll Pins
Used in Assembly



Fenced-in Magazine
Release with Ambi.
Trigger Finger Indexing
Shelves



Captured Rear Take-
down Pin and Buffer
Detent Assembly



 **UTG
PRO**

AR15 BILLET RECEIVERS



UTG PRO  **NEW**

AR15 BILLET RECEIVERS

- » Proudly Designed and Made in USA
- » Matte Black Type III Class II Hard Coat Anodized 7075-T6 Billet Construction
- » Glove-friendly Oversized Trigger Guard
- » Fenced-in Magazine Releases and Ambidextrous Trigger Finger Indexing Points
- » Shortened and Flared Magwell Fully Compatible with Most Magazines and Drums
- » Threaded Steel Retention Pins and Set Screws, Zero Roll Pins Used in Assembly
- » Compatible with Most Furniture, Fire Control Groups, Bolt Carrier Groups, and Parts Kits
- » Captured Buffer and Rear Takedown Pin Detent and Spring
- » Tight Tolerance Fit of Upper and Lower Receiver, Takedown and Pivot Pins, and Barrel Extension
- » Upper Receiver Cut for M4 Feed Ramps
- » Upper Receiver Flattop Features an Additional Picatinny Slot
- » Optional Receiver Tensioning Screw Included
- » Multi-caliber Marked

AR15 BILLET UPPER RECEIVER / FUR001
AR15 BILLET LOWER RECEIVER / FLR001
AR15 BILLET RECEIVER SET / FCR01



Optional Lower to Upper Tensioning Screw Included



Fenced-in Magazine Release with Ambi. Trigger Finger Indexing Shelves



Lightweight with Extra Flattop Picatinny Slot



Compatible with Most Furniture, FCGS, BCGs, and Parts Kits

A close-up, side-profile photograph of a person wearing a grey mesh cap, black sunglasses, and a green t-shirt. They are holding a rifle with a tan and black camouflage handguard. The rifle has a scope and other attachments. The person's hands are wearing black gloves with 'Mechanix' written on them. The background is a blurred outdoor setting with a wooden fence.

HANDGUARDS

**FOR ALL YOUR RAIL
ESTATE NEEDS.**

Configuring a firearm to accomplish a particular goal involves selecting a handguard with a solid foundation. Most agree that establishing a balance between mounting real estate, overall weight, and the ergonomics of using mounted attachments is key. A solid lock up is a given. Being straightforward and easy to install is always welcome. Our UTG PRO[®] Michigan made selection of handguards takes the above into account using quality materials and finishes at a price accessible to everyone.



JUMP TO A SERIES

MP5 MONOLITHIC HANDGUARD [NEW]	107
FREE FLOAT HANDGUARDS	108
FORERUNNER	109
ARWEN	111
SUPER SLIM SD	113
ULTRA SLIM	115
SUPER SLIM	115
DROP-IN HANDGUARDS	116
AR15 Drop-in	117
AK Drop-in	118
RUGER PC Carbine Drop-in	119

[THIRD PARTY TRADEMARKS MAY BE USED IN THIS CATALOG FOR USER CONVENIENCE TO INDICATE THE FIT OR COMPATIBILITY OF THE APPLICABLE PRODUCT.]



MPS MONOLITHIC



 **UTG[®]**
PRO

MP5 MONOLITHIC M-LOK HANDGUARD



UTG PRO  **NEW**

MP5 MONOLITHIC M-LOK HANDGUARD

- » Proudly Designed and Made in USA
- » Monolithic Design Combines M-LOK® and Optics Real Estate into One Rigid Mount
- » 6061-T6 Aluminum with Dehorned Corners and Melted Contours and Finished in H-146 Graphite Black CERAKOTE®
- » Patented Claw Mount Locking Interface
- » Extended 16 Slot Picatinny Flattop with Cutout for Serial Number Identification
- » 17 Full and 5 Half M-LOK® Slots Around Circumference of Handguard
- » Chamfered Locking Recess Notch Prevents Hot Spots and Snag Points while Manipulating Charging Handle
- » Overall Lightweight at 9.8oz Installed
- » Integral Left and Right Side Anti-Rotational QD Sockets
- » Designed for 9mm Receiver MP5 and Clones and Compatible with Most Collapsible and Fixed Stocks
- » US PAT. 11656059



Patented Claw Mount Locking Interface



Extended 16 Slot Picatinny Flat-Top with Cutout for Serial Number



Chamfered Locking Recess Notch



Overall Lightweight at 9.8oz Installed

	MTU055SSM
Platform	MP5 & MP5 Clones
Length	13.65"
Width	1.69"
Height	2.07"
M-LOK® Slots	17 Full / 5 Half
Top Picatinny Slots	16
Weight	9.8 oz

FORERUNNER

 **UTG[®]**
PRO

FORERUNNER FREE FLOAT M-LOK® HANDGUARDS



AR15 FORERUNNER FREE FLOAT M-LOK® HANDGUARDS

- » Precision Machined from 6061-T6 Aluminum and Finished in a Matte Black Anodization
- » Unique Patented Titanium Barrel Nut Requires Little to No Timing in Relation to the Gas Tube and Installation Screws
- » M-LOK® Slots on 3 Slot Tracks for Mounting Accessories
- » Handguard Features an Ergonomic Octagonal Profile and Machined Lightening Cuts Made Throughout with a 3-Slot Top Picatinny Rail Found at the Front and Rear
- » Integral Anti-rotation Tabs for Accurate Alignment with Upper Receiver and to Prevent Unintentional Handguard Rotation and Flex
- » Compatible with Left or Right Handed Standard Mil-Spec AR15 Upper Receivers
- » Includes M-LOK® Picatinny Rail Section, QD Sling Swivel Adaptor, Installation Hardware, and Barrel Nut Wrench
- » US PAT. 10670369

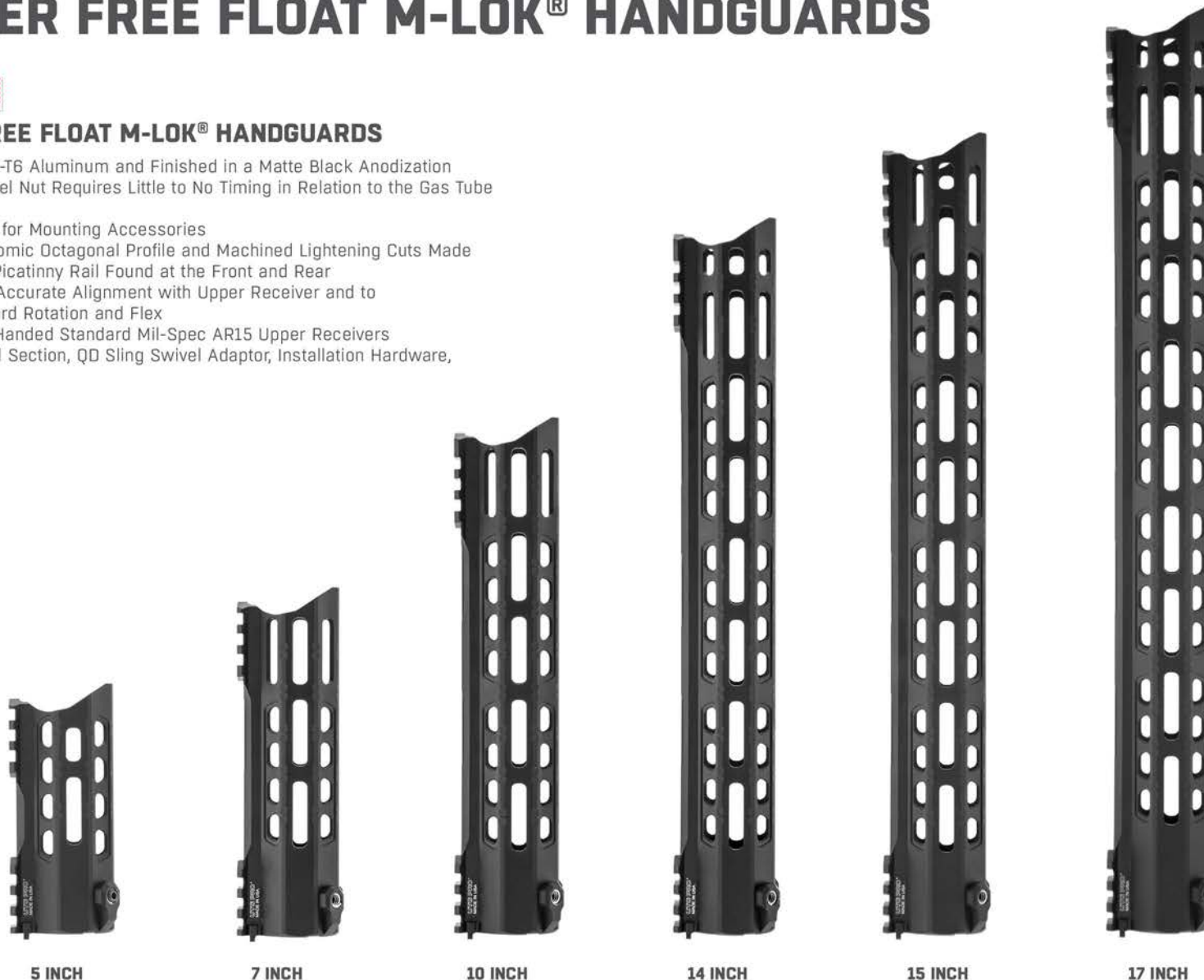

5 INCH

7 INCH

10 INCH

14 INCH

15 INCH

17 INCH

	MTU049SPM	MTU044SPM	MTU045SPM	MTU046SPM	MTU047SPM	MTU048SPM
Actual Length	4.8"	6.8"	9.8"	13.8"	15.3"	17.3"
M-LOK® Slots	3 Full, 3 Half	13 Full	19 Full	25 Full, 7 Half	28 Full, 3 Half	31 Full, 7 Half
Top Picatinny Slots	6	6	6	6	6	6
Weight	4.6 oz	5.7 oz	7.3 oz	9.5 oz	10.3 oz	11.5 oz

ARWEN



 **UTG[®]**
PRO

ARWEN FREE FLOAT M-LOK® HANDGUARDS



AR15 ARWEN FREE FLOAT M-LOK® HANDGUARDS

- » Arwen meaning "Fair" in Welsh, is the Go-to UTG PRO® Handguard Series for Shooters Looking for a Fair Priced, yet Fully Featured Handguard with a Streamlined Look and Feel
- » Precision Machined from 6061-T6 Aluminum and Finished in a Matte Black Anodization
- » Unique Patented Steel Barrel Nut Requires Little to No Timing in Relation to the Gas Tube and Installation Screws and Furthermore, Does not Require a Proprietary Wrench for Installation
- » M-LOK® Slots at the 3, 6, and 9 O'clock Positions along with Additional 45 Degree M-LOK® Slots Located at the Front of the Handguard
- » Lightening Cuts Throughout the Handguard Keep Weight to a Minimum
- » Includes Installation Hardware and Barrel Nut Wrench
- » US PAT. 10670369

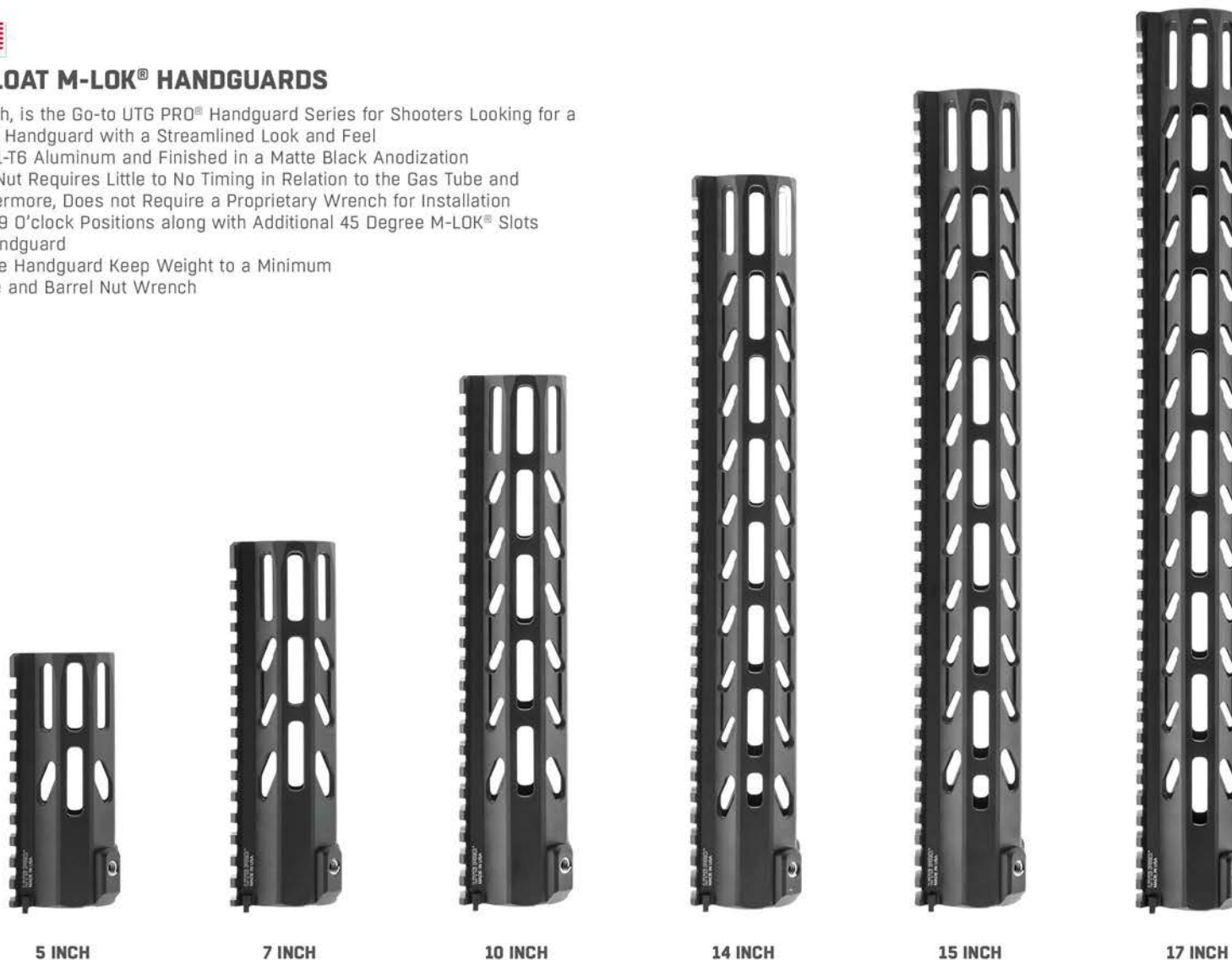

5 INCH

7 INCH

10 INCH

14 INCH

15 INCH

17 INCH

	MTU049SEM	MTU044SEM	MTU045SEM	MTU046SEM	MTU047SEM	MTU048SEM
Actual Length	4.8"	6.8"	9.8"	13.8"	15.3"	17.3"
M-LOK® Slots	10 Full	13 Full	19 Full	25 Full, 3 Half	28 Full, 3 Half	34 Full
Top Picatinny Slots	11	16	24	34	38	43
Weight	6.0 oz	7.4 oz	9.4 oz	12.1 oz	13.1 oz	14.4 oz

SUPER SLIM SD



SUPER SLIM SUPPRESSED FREE FLOAT M-LOK® HANDGUARDS



AR15 SUPER SLIM SD FREE FLOAT M-LOK® HANDGUARDS

- » 1.67" Inner Diameter for Compatibility with Suppressors
- » Precision Machined from 6061-T6 Aluminum and Finished in a Matte Black Anodization
- » M-LOK® Slots on 7 Slot Tracks for Mounting Accessories
- » Ergonomic Octagonal Profile with Grooved Surface Provides a Comfortable Means of Handling
- » Full Length Top Picatinny Rail is Flush and Continuous with Upper Receiver
- » Features Integral Anti-rotation Tabs for Accurate Alignment with Upper Receiver and to Prevent Unintentional Handguard Rotation and Flex
- » Compatible with Left or Right Handed Standard Mil-Spec AR15 Upper Receivers
- » Includes M-LOK® Picatinny Rail Section, QD Sling Swivel Adaptor, Installation Hardware, and Barrel Nut Wrench
- » US PAT. 10670369



7 INCH



10 INCH



14 INCH



15.5 INCH

	MTU044XLM	MTU045XLM	MTU046XLM	MTU047XLM
Actual Length	7"	10"	14"	15.5"
M-LOK® Slots	21	35	49	56
Top Picatinny Slots	16	24	34	38
Weight	11.4 oz	13.7 oz	17.1 oz	18.3 oz
Inner Diameter	1.67"	1.67"	1.67"	1.67"

ULTRA SLIM | SUPER SLIM



 **UTG[®]**
PRO

ULTRA SLIM & SUPER SLIM FREE FLOAT M-LOK® HANDGUARDS

UTG PRO®

AR15 ULTRA SLIM FREE FLOAT M-LOK® HANDGUARDS

- » Precision Machined from 6061-T6 Aluminum
- » Ultra Slim Design with Lightening Cuts Made Throughout, While Still Allowing for High Level of Modularity
- » Ergonomically Grooved Handguard Surface and Octagonal Profile Features Left and Right Side Grip Serrations
- » US PAT. 8806792

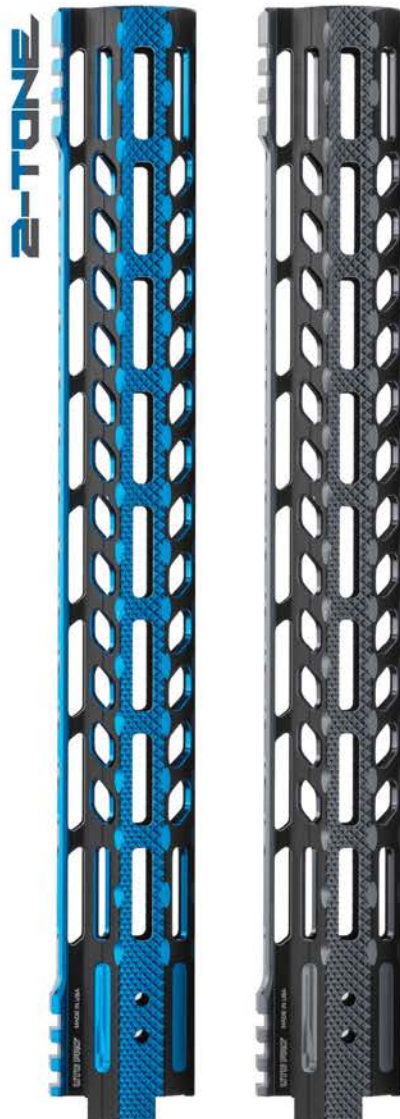

UTG PRO®

AR15 SUPER SLIM FREE FLOAT M-LOK® HANDGUARDS

- » Precision Machined from 6061-T6 Aluminum
- » Ergonomic Octagonal Profile with Grooved Surface for a Solid and Comfortable Grip
- » Scalloped Top Picatinny Rail Edges for Snag Free Accessories Mounting
- » Ergonomic Finger Grooves for a Solid and Comfortable Grip
- » Compatible with Right Handed Standard Mil-spec AR15 Upper Receivers Only
- » US PAT. 8806792

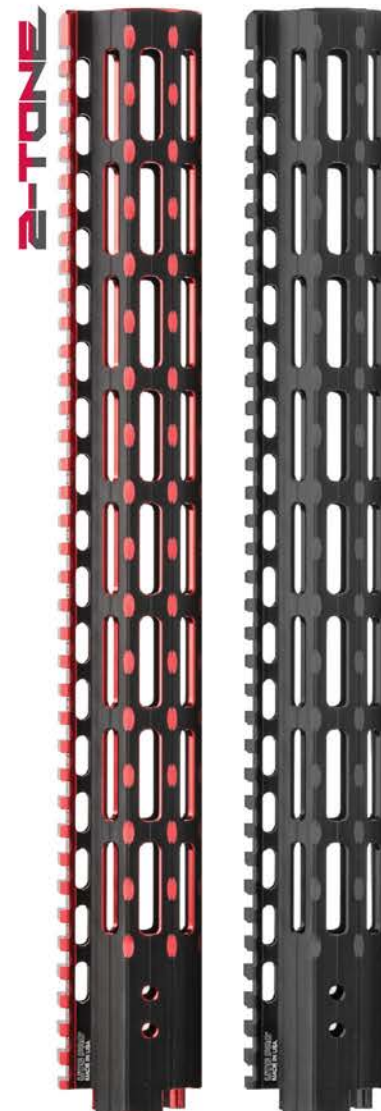

Compatible with Left or Right Handed Standard Mil-spec AR15 Upper Receivers



Left and Right Side Grip Serrations



Reduced Top End with 3-slot Picatinny Rail at the Front and Rear of Handguard



Flush Fitting and Continuous with Receiver



Integral Anti-rotation Tabs for Accurate Alignment with Receiver

	MTU019SSM3	MTU019SSM3B2	MTU019SSM3R2	MTU019SSM	MTU019SSMD	MTU019SSMB2	MTU019SSMR2	MTU019SSMZ2
	Ultra Slim			Super Slim				
Color	■ Black	■ Black/Blue	■ Black/Red	■ Black	■ FDE Cerakote®	■ Black/Blue	■ Black/Red	■ Black/Bronze
Length	15.3"	15.3"	15.3"	15.3"	15.3"	15.3"	15.3"	15.3"
M-LOK® Slots	24	24	24	56	56	49	49	49
Picatinny Slots	6	6	6	37	37	37	37	37
Weight	11.5 oz	11.5 oz	11.5 oz	12.5 oz	12.5 oz	12.8 oz	12.8 oz	12.8 oz

DROP-IN



 **UTG[®]**
PRO

DROP-IN HANDGUARDS

UTG PRO 

AR15 DROP-IN HANDGUARDS

- » Matte Black Anodized 6061-T6 Aluminum Construction
- » Two-piece Drop-in Design Requires no Permanent Modification



CARBINE-LENGTH QUAD RAIL

- » Compatible with Carbine-length DI Systems with Standard Delta Ring Assembly and Round Front Handguard Cap
- » MTU001 and MTU001T Compatible with RUGER® AR-556®

7 Inch / MTU001
7 Inch / Extended Top Rail / MTU001T
11 Inch / FSP Cutout / MTU015

CARBINE-LENGTH SUPER SLIM M-LOK® HANDGUARDS

- » Compatible with Carbine-length DI Systems with Standard Delta Ring Assembly and Round Front Handguard Cap and the RUGER® AR-556®

7 Inch / Extended Top Rail / MTU001SSM
15 Inch / Extended Top Rail / FSP Cutout / MTU015SSM

MID-LENGTH QUAD RAIL

- » Compatible with Mid-length DI Systems with Standard Delta Ring Assembly and Triangular Handguard Cap

9 Inch / MTU007

	MTU001	MTU001T	MTU015	MTU001SSM	MTU015SSM	MTU007
Length	6.7"	7.3"	10.7"	7.3"	15.0"	8.7"
M-LOK® Slots	-	-	-	24	45	-
Picatinny Slots	T:14 / B:14 / L:14 / R:14	T:18 / B:17 / L:16 / R:16	T:19 / B:23 / L:25 / R:25	T:18	T:30	T:18 / B:18 / L:18 / R:18
Weight	11.3 oz	11.3 oz	17.0 oz	6.2 oz	12.4 oz	14.7 oz



AK47/74 SUPER SLIM DROP-IN HANDGUARD



Modular Top End Mounts Included 9 Slot Picatinny Rail Section



DOCTER® Footprint MRDS Plate Included

UTG PRO  

AK47/74 SUPER SLIM DROP-IN M-LOK® HANDGUARD

- » Matte Black Anodized 6061-T6 Aluminum Construction
- » Compatible with Most Milled or Stamped Romanian, Chinese, and US AK47/AK74 Pattern Rifles
- » US PAT. 10962324

M-LOK® / MTU053SSM

	MTU053SSM
Length / Width	6.20" / 1.61"
Height	2.63"
M-LOK® Slots	15
Weight	9.7 oz



AK DROP-IN QUAD RAIL HANDGUARDS



ZASTAVA M92 DROP-IN QUAD RAIL HANDGUARD

- » Designed Specifically for the Zastava M92
- / **MTU052**

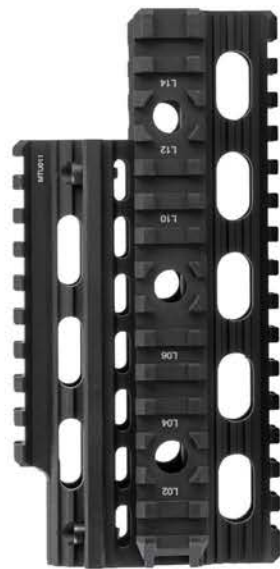

YUGO M70 AK QUAD RAIL HANDGUARD

- » Fits Yugo M70 Variants and is also compatible with the Zastava N-PAP after Removal of Rear Handguard Retainer
- / **MTU011**



UNIVERSAL AK QUAD RAIL HANDGUARD

- » Compatible with Most Milled or Stamped Romanian, Chinese, and US AK47/AK74 Pattern Rifles
- / **MTU009**

SUPER SLIM FOREND FOR RUGER® PC CARBINE™



Lower 1/3 Co-witness DOCTER® Footprint Optic Mount Included

WWW.LEAPERS.COM | SINCE 1992



AK DROP-IN QUAD RAIL HANDGUARDS

- » Matte Black Anodized 6061-T6 Aluminum Construction
- » Lightening Cut MIL-STD-1913 Picatinny Quad Rail with Left/Right Integral QD Sling Swivel Housings
- » Two-piece Drop-in Design Requires No Permanent Modification

	MTU052	MTU011	MTU009
Length / Width	6.5" / 2.1"		8.4" / 2.1"
Picatinny Slots	T:9 / B:15 / L:15 / R:15		T:14 / B:14 / L:14 / R:14
Weight	9.5 oz		9.2 oz



SUPER SLIM M-LOK® FOREND FOR RUGER® PC CARBINE™

- » Matte Black Anodized 6061-T6 Aluminum Construction
- » Machined Lightening Cuts Throughout Forend Keep Weight to a Minimum
- » 8 M-LOK® Slots, 3 Slots at 3 and 9 O'clock and 2 Slots at 6 O'clock
- » Melted Contours, Chamfered Edges, and Dehorned Corners

M-LOK® / **MTU050SSM**

	MTU050SSM
Length / Width	6.49" / 1.80"
Height"	1.73" / 3.45" with MRDS Mount
M-LOK® Slots	8
Weight	9.3 oz

BIPODS



MAKE IT COUNT.

Purpose-built for every shooter. Whether recreational, competitive, and or professional we make a bipod with your name on it available in different height profiles, modular system compatibility, and feature sets that cater to your shooting disciplines.



JUMP TO A SERIES

RECON 360® TL BIPODS [NEW]	122
UTG PRO® TBNR® BIPODS	125
BIG BORE FULL STABILITY BIPOD	127
OVER BORE BIPOD	129
RECON FLEX® BIPODS	131
D GRIP®	132
QUICK DETACH BIPODS	133

(THIRD PARTY TRADEMARKS MAY BE USED IN THIS CATALOG FOR USER CONVENIENCE TO INDICATE THE FIT OR COMPATIBILITY OF THE APPLICABLE PRODUCT.)





RECON 360[®] TL

As the name implies, the **RECON 360[®] TL** series of bipods feature a smooth 360° panning capability with the addition of 15° forward, rearward, left, and right tilt. Panning and tilting tension is adjustable by the end-user to fine-tune the desired amount of resistance and feedback required to pan and tilt the bipod. Tension adjustment is made quick and easy with a centrally located throw lever at the base of the bipod's mount. The throw lever is not only user friendly, but user serviceable and can be readjusted over time as the bipod wears in.

Suitable for different long gun applications, Recon 360 TL bipods are available in three different lockable and adjustable center-heights and are available in both M-LOK[®] and MIL-STD-1913 Picatinny mount configurations. Additionally, MIL-STD-1913 Picatinny mount models come included with a swivel stud mount adaptor, further increasing its compatible versatility right out-of-the-box.

FINE-TUNE ADJUSTMENT

Tension Adjustment Throw Lever is User Friendly and Serviceable being re-adjustable over time.



VERSATILE PANNING & TILTING

Smooth 360° panning with additional 15° forward, rearward, left, and right tilt.



3 POSITION FOLDING

0°, 45°, and 90° Foldable Positions



CENTER HEIGHT ADJUSTABLE

Lockable Leg Extensions with Nonslip Rubberized Footpads



RECON 360[®] TL BIPODS

ARCA MOUNT VERSION COMING SOON



M-LOK[®]

5.8" - 7.1" Center Height / TL-BPM02-B
 6.6" - 9.1" Center Height / TL-BPM01-B
 8.1" - 11.9" Center Height / TL-BPM03-B

US PAT. D758522



PICATINNY

5.6" - 7.2" Center Height / TL-BP02-B
 6.6" - 9.1" Center Height / TL-BP01-B
 8.1" - 11.9" Center Height / TL-BP03-B

US PAT. D758521, US PAT. D758522

RECON 360[®] TL BIPODS **NEW**

- » Durable Aircraft Aluminum Construction Finished in a Matte Black Anodization
- » 3 Position Folding Legs and Lockable Leg Extensions Equipped with Nonslip Rubberized Foot Pads
- » Tunable Tension Adjustment Applies the Desired Amount of Tension to the Bipod's 360° Panning & 15° Left, Right, Forward, and Rearward Tilt
- » Readjustable Tension Adjustment Lever is User Serviceable and Optimizes the Applied Tension with the Lever's Throw Distance and Positioning
- » Swivel Stud Adaptor Included (Picatinny Version Only)

	TL-BPM02-B	TL-BPM01-B	TL-BPM03-B	TL-BP02-B	TL-BP01-B	TL-BP03-B
Mount Type	M-LOK [®]	M-LOK [®]	M-LOK [®]	Picatinny	Picatinny	Picatinny
Center Height	5.8" - 7.1"	6.6" - 9.1"	8.1" - 11.9"	5.6" - 7.2"	6.6" - 9.1"	8.1" - 11.9"
Open Angle	50°	50°	50°	50°	50°	50°
Panning	360°	360°	360°	360°	360°	360°
Tilting (Forward, Rearward, Left, & Right)	15°	15°	15°	15°	15°	15°
Foot Pad	Rubberized	Rubberized	Rubberized	Rubberized	Rubberized	Rubberized
Weight	8.9 oz	11.3 oz	15.3 oz	10.9 oz	12.2 oz	14.5 oz
Extendable Legs	3 Position	5 Position	7 Position	3 Position	5 Position	7 Position
Leg Operation	Manual, 3 Position Foldable & Lockable					

THE BEST NEVER REST®

 **UTG®**
PRO

TBNR[®] | THE BEST NEVER REST | BIPODS



WWW.LEAPERS.COM | SINCE 1992

M-LOK[®]

8.5" - 11.0" Center Height / TLUBP01M
7.3" - 9.0" Center Height / TLUBP02M-A

PICATINNY

8.5" - 11.0" Center Height / TLUBP01
7.3" - 9.1" Center Height / TLUBP02-A

UTG PRO[®] 

TBNR[®] | THE BEST NEVER REST | BIPODS



Performance Tested and Evaluated



Height Adjustable Spiral Guided 7075-T6 Aluminum Leg Extensions with Automatic Leg Extension Retraction (US PAT. 10323897)



Tension Adjustable 360° Panning & 19° Tilt Forward, Rearward, Left, and Right



0°, 45°, & 90° Folding Leg Positions with Steel-on-steel Lockup

	TLUBP01M	TLUBP02M-A	TLUBP01	TLUBP02-A
Mount Type	M-LOK [®]	M-LOK [®]	Picatinny	Picatinny
Center Height	8.5" - 11.0"	7.3" - 9.0"	8.5" - 11.0"	7.3" - 9.1"
Open Angle	50°	50°	50°	50°
Panning	360°	360°	360°	360°
Tilting	19°	19°	19°	19°
Foot Pad	Aluminum	Aluminum	Aluminum	Aluminum
Weight	19.0 oz	17.2 oz	19.7 oz	18.3 oz
Extendable Legs	7 Position	4 Position	7 Position	4 Position
Leg Operation	Manual, 3 Position Foldable & Lockable			

Big Bore FS



BIG BORE FULL STABILITY BIPOD



BIG BORE FULL STABILITY BIPOD

- » Matte Black Anodized Aluminum Construction with Reinforced Steel Components Designed from the Ground Up to Withstand Big Bore Calibers up to .50 BMG
- » Reinforced Picatinny Mounting Base Features a Longer Surface Area Equipped with a Squared Steel Crossbolt
- » Lockable and Height Adjustable Legs Provide a Center Height from 9"-14" and a Wide 70° Open Angle for Increased Stability
- » Posi-lock Push Buttons Feature a Large Surface Area for Easier Use while Wearing Gloves

9.4" - 14.0" Center Height / TL-BPFS01-A



0°, 45°, & 90° Folding Leg Positions with Steel-on-steel Lockup



Tension Adjustable 35° Panning and 55° Left and Right Tilt



Rotatable Footpads Self Adjust to Uneven Surfaces and Bipod Leg Positioning

	TL-BPFS01-A
Mount Type	Picatinny
Center Height	9.4" - 14.0"
Open Angle	70°
Panning	35°
Tilting (Left/Right)	55°
Foot Pad	Steel
Weight	34.4 oz
Extendable Legs	9 Position
Leg Operation	Manual, 3 Position Foldable & Lockable

OVER BORE



OVER BORE BIPOD



OVER BORE BIPOD

- » Wide Open Angle Improves Stability
- » Matte Black Anodized Aircraft Aluminum Construction with Reinforced Steel Components
- » 3 Position Folding Legs Equipped with Rubberized Foot Pads
- » Lockable and Height Adjustable Legs Providing a Center Height from 7"-11"
- » 22° Panning and 44° Tension Adjustable Left and Right Tilt
- » Posi-lock Push Buttons Feature a Large Surface Area for Easier Use while Wearing Gloves

7.3" - 11.4" Center Height / TL-BPOB01-A



Quick Detachable Mounting Base (Designed to Mount Under or Over Rifle Bore)



0°, 45°, & 90° Folding Leg Positions with Steel-on-steel Lockup



Oversized Posi-lock Push Buttons for Easier Use while Wearing Gloves

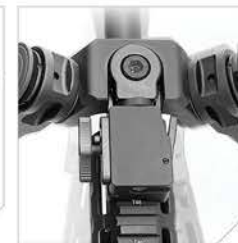

Tension Adjustable 44° Left & Right Tilt

	TL-BPOB01-A
Mount Type	Picatinny
Center Height	7.3" - 11.4"
Open Angle	70°
Panning	22°
Tilting (Left/Right)	44°
Foot Pad	Rubberized
Weight	24.1 oz
Extendable Legs	7 Position
Leg Operation	Manual, 3 Position Foldable & Lockable

RECON FLEX®



RECON FLEX® BIPODS



RECON FLEX® II

M-LOK® / 7.1" - 9.1" Center Height / TL-BPDM03
 M-LOK® / 8.7" - 12.0" Center Height / TL-BPDM04

RECON FLEX®

M-LOK® / 5.7" - 8.0" Center Height / TL-BPDM01
 M-LOK® / 8.0" - 11.8" Center Height / TL-BPDM02
 KEYMOD / 5.7" - 8.0" Center Height / TL-BPDK01

RECON FLEX® II BIPODS

- » 5 Position Bidirectional Legs Feature One-piece Locking Sliders with Circular Locking Lugs for Easier Manipulation and Added Durability
- » Interchangeable Foot Pads Compatible with Most Aftermarket Pads with QD Locking Detent
- » Automatic Leg Extension Deployment
- » Height Extendable Legs Lockable Via Thumb Wheel

RECON FLEX® BIPODS

- » Ergonomic Spring Loaded Slide Locking Ring for Quick and Effortless Bipod Deployment
- » Legs with 5 Posi-lock Positions for Use on Different Firearms with Varying Height Clearance and Mounting Real Estate
- » Height Extendable Legs Lockable Via Thumb Wheel
- » US PAT. 10295292



Directly Attaches to Handguard at the 3 and 9 O'clock Positions



5 Position Bidirectional Folding Legs

	TL-BPDM03	TL-BPDM04	TL-BPDM01	TL-BPDM02	TL-BPDK01
Mount Type	M-LOK®	M-LOK®	M-LOK®	M-LOK®	Keymod
Center Height	7.1" - 9.1"	8.7" - 12.0"	5.7" - 8.0"	8.0" - 11.8"	5.7" - 8.0"
Open Angle	50°	50°	50°	50°	50°
Foot Pad	Rubberized	Rubberized	Rubberized	Rubberized	Rubberized
Weight (2pcs)	11.3 oz.	12.3 oz.	10.8 oz.	13.7 oz.	10.8 oz.
Extendable Legs	5 Position	7 Position	5 Position	7 Position	5 Position
Leg Operation	Manual, 5 Position Foldable & Lockable				



D GRIP®



D GRIP®

QUICK RELEASE DEPLOYABLE BIPOD

D GRIP®

- » Contoured Foregrip with Nonslip and Heat-resistant Rubberized Inlays
- » Ambidextrous Quick Release Deploys Foldable Impact-resistant Bipod Legs Instantly
- » Quickly Transitions from Foregrip to Bipod
- » 5.6" Foregrip Length with an 8.4" Center Height and 65° Open Angle when Bipod is Deployed
- » US PAT. 8397421, US PAT. 9169958, EU REG: 002245522-0001, EU REG: 002245522-0002

/ MNT-DG02Q

	MNT-DG02Q
Mount Type	Picatinny
Center Height	8.4"
Open Angle	65°
Grip Height	5.6"
Bipod Height	8.6"
Foot Pad	Aluminum
Weight	12.7 oz
Leg Operation	Spring Loaded Deployment

QUICK DETACH BIPODS



RUBBER ARMORED QD BIPOD

- » Protected Rubber Armored Legs Stands up to the Harshes of Environments
- » 5 Position Extendable Legs Lockable via Thumb Wheel
- » 5 Position Bidirectional Folding Legs
- » US PAT. 8397421

QD Lever Lock / 6.0" - 8.5" Center Height / TL-BP20Q-A



TACTICAL OP BIPODS

- » Heavy Duty Steel and Aluminum Construction with a Matte Black Finish
- » Spring-loaded Folding Legs
- » Fully Adjustable Legs with Locking Thumb Wheel & Automatic Retraction
- » US PAT. 8397421

QD Lever Lock / 5.9" - 7.3" Center Height / TL-BP78Q
QD Lever Lock / 8.0" - 12.4" Center Height / TL-BP88Q
Locking Thumb Wheel / 6.1" - 7.9" Center Height / TL-BP78
Locking Thumb Wheel / 8.3" - 12.7" Center Height / TL-BP88



SUPER DUTY QD BIPODS

- » Heavy Duty Steel and Aluminum Construction with a Matte Black Finish
- » Spring-loaded Folding Legs
- » Fully Adjustable Legs with Spring Loaded Retention Clamp and Locking Thumb Wheel
- » US PAT. 8397421

QD Lever Lock / 6.0" - 8.5" Center Height / TL-BP98Q
QD Lever Lock / 8.0" - 12.8" Center Height / TL-BP99Q

	TL-BP20Q-A	TL-BP78Q	TL-BP88Q	TL-BP78	TL-BP88	TL-BP98Q	TL-BP99Q
Mount Type	Picatinny						
Center Height	6.0" - 8.5"	5.9" - 7.3"	8.0" - 12.4"	6.1" - 7.9"	8.3" - 12.7"	6.0" - 8.5"	8.0" - 12.8"
Open Angle	50°	50°	50°	50°	50°	50°	50°
Panning	15°	15°	15°	15°	15°	15°	15°
Foot Pad	Rubberized	Rubberized	Rubberized	Rubberized	Rubberized	Rubberized	Rubberized
Weight	14.0 oz	13.0 oz	12.8 oz	11.5 oz	13.3 oz	13.8 oz	17.4 oz
Extendable Legs	5 Position	3 Position	7 Position	3 Position	7 Position	5 Position	9 Position
Foldable Legs	5 Position	Yes	Yes	Yes	Yes	Yes	Yes
Swivel Stud Kit	Included	Included	Included	Included	Included	Included	Included
Leg Operation	Manual, 5 Position Foldable & Lockable			Spring Loaded			

SWIVEL STUD TO PICATINNY ADAPTOR

- » Steel and Aluminum Construction with Padded Adaptor Plate to Prevent Marring
- » Converts a Traditional Sling Swivel Stud to Accept Picatinny Mounted Bipods
- » Retains Swivel Stud Functionality for the Installation of a Sling when Installed
- » Quick to Install with No Permanent Modification Required



/ **TL-BPAD1**

A close-up photograph of a person wearing a grey cap and glasses, aiming a black rifle. The rifle's stock is prominently featured, with the text "UTG PRO" visible on its side. The background is a blurred outdoor setting with green foliage.

STOCKS, BUFFERS & TUBES

ADD THE FINISHING TOUCH

You found and collected enough spare parts from deep within the confines of your basement to complete a lower parts kit and justifiably plan to build a complete rifle out of principle. Here is where you find everything needed to kit up your lower's stock assembly, finish the build and add it to the collection.



JUMP TO A SERIES

	AK SIDE FOLDER [NEW]	136
	AR COLLAPSIBLE STOCKS	138
	S1 6-Position Stocks & Assemblies	
	S2 6-Position Stocks & Assemblies	
	S3 6-Position Stocks & Assemblies	
	S4 4-Position Stocks & Assemblies	
	U6 6-Position Stock Assemblies	
	AR15 FIXED STOCKS	140
	AR308 FIXED STOCK	140
	TUBES & BUFFERS	142

[THIRD PARTY TRADEMARKS MAY BE USED IN THIS CATALOG FOR USER CONVENIENCE TO INDICATE THE FIT OR COMPATIBILITY OF THE APPLICABLE PRODUCT.]



AK SIDE FOLDER

Solid Retention while Folded, Locks into Place when Deployed, and Unlocks via Reinforced Push-button

LOP Adjustment can be Configured to Deploy Directly to User's Preferred Position upon Spring-loaded Activation

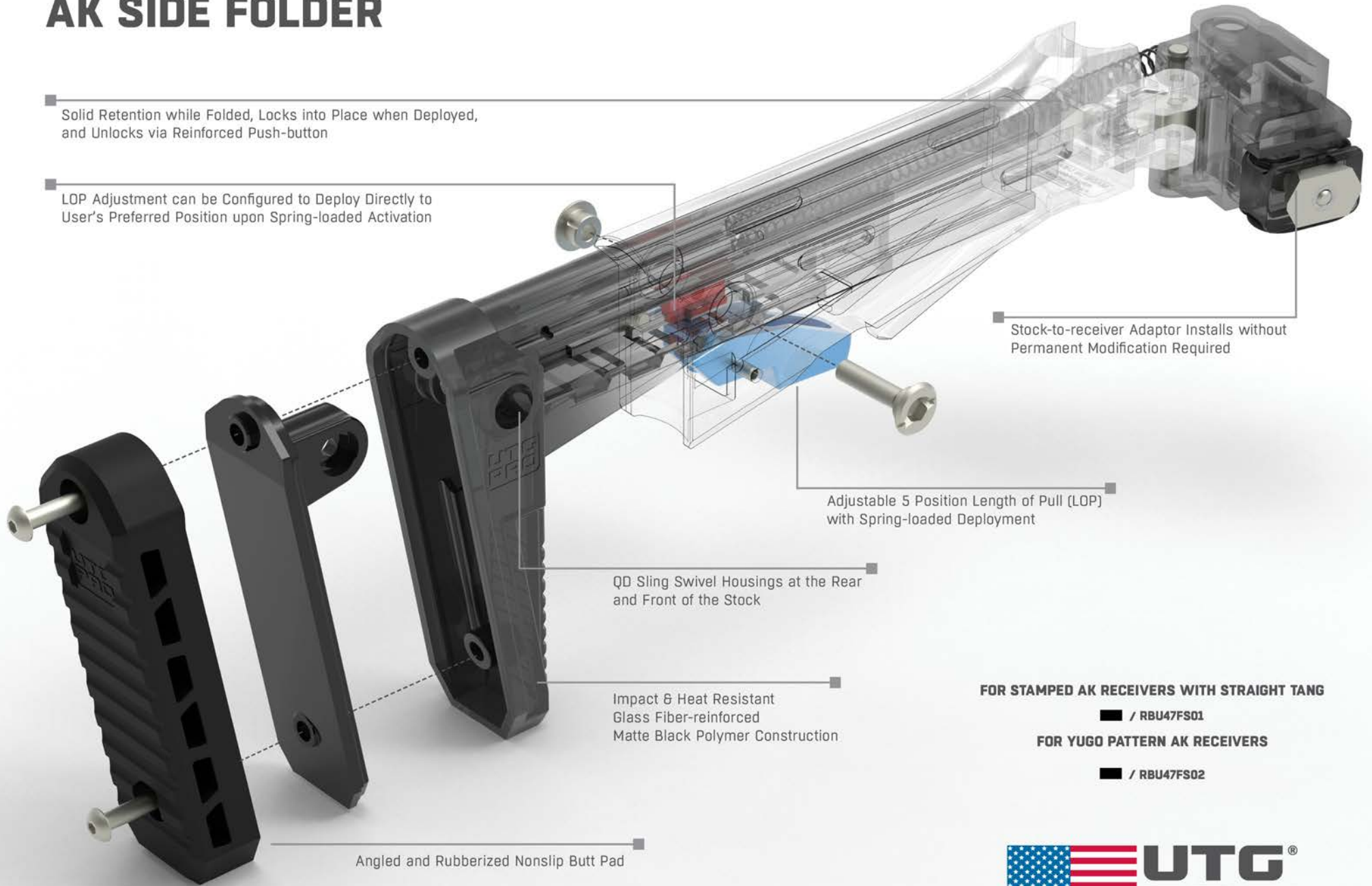

FOR STAMPED AK RECEIVERS WITH STRAIGHT TANG

■ / RBU47FS01

FOR YUGO PATTERN AK RECEIVERS

■ / RBU47FS02





Right-side Folding



Adjustable 5 Position Length of Pull (LOP)



Spring-loaded Deployment



Angled and Rubberized Nonslip Butt Pad

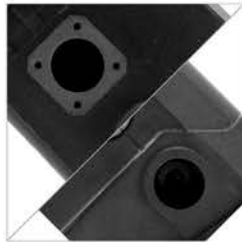

QD Sling Swivel Housings at the Rear and Front of the Stock



Reinforced Push-button Lockup



TOP VIEW

UTG PRO  **NEW**
AK SIDE FOLDER

- » Proudly Designed and Made in USA
- » Impact & Heat Resistant Glass Fiber-reinforced Matte Black Polymer Construction
- » Folds to the Right for Compatibility with Side-mounted Optics
- » Solid Retention while Folded, Locks into Place when Deployed, and Unlocks via Reinforced Push-button
- » Adjustable 5 Position Length of Pull (LOP) with Spring-loaded Deployment
- » LOP Adjustment can be Configured to Deploy Directly to User's Preferred Position upon Spring-loaded Activation
- » Stock-to-receiver Adaptor Installs without Permanent Modification Required
- » Angled and Rubberized Nonslip Butt Pad
- » QD Sling Swivel Housings at the Rear and Front of the Stock
- » Counts as One US Part for 922R Compliance
- » US PAT. 11067360, US PAT. 11592264, US PAT. 11598604

Black 	RBU47FS01	RBU47FS02
Platform	Stamped AK with Straight Tang	Yugo Pattern AK
LOP Adjustment Range	2.84"	2.84"
LOP Adjustment Increment	5 Position (0.71"/Position)	5 Position (0.71"/Position)
LOP Collapsed	13.59"	13.59"
LOP Extended	16.42"	16.42"
Material	Polymer	Polymer
Dimensions	10.62" x 1.95" x 5.43"	10.62" x 1.95" x 5.43"
Weight	19.65 oz	19.65 oz

S-SERIES



 **UTG[®]
PRO**

COLLAPSIBLE STOCKS



S1 MIL-SPEC 6 POSITION STOCKS & ASSEMBLIES

- » Extended 8" Length for Increased Length of Pull

-  / Stock Assembly / RBUS1BM
-  / Stock Assembly / RBUS1DM
-  / Stock Only / RBUS1BMS
-  / Stock Only / RBUS1DMS



S2 MIL-SPEC 6 POSITION STOCKS & ASSEMBLIES





- » Lightweight Slim Profile with Extended 7.50" Length for Increased Length of Pull

-  / Stock Assembly / RBUS2BM
-  / Stock Assembly / RBUS2DM
-  / Stock Only / RBUS2BMS
-  / Stock Only / RBUS2DMS



S3 MIL-SPEC 6 POSITION STOCKS & ASSEMBLIES



- » Sub-compact Profile for Lightweight, Comfortable Performance
- » US PAT. D773005

-  / Stock Assembly / RBUS3BM
-  / Stock Assembly / RBUS3DM
-  / Stock Only / RBUS3BMS
-  / Stock Only / RBUS3DMS



S4 MIL-SPEC 4 POSITION STOCKS & ASSEMBLIES

- » Lightweight, Ultra Sub-compact Profile, Ideal for SBR/SBS Applications
- » Included Removable Cheek Rest for Improved Shooting Stability and Comfort
- » US PAT. D818074

-  / Stock Assembly / RBUS4BM
-  / Stock Assembly / RBUS4DM
-  / Stock Only / RBUS4BMS
-  / Stock Only / RBUS4DMS



U6 MIL-SPEC 6 POSITION STOCK ASSEMBLIES

- » Dual Standard Sling Loop Attachment Points
- » Lightweight Design with a Classic Look and Feel

-  / Stock Assembly / RBU6BM
-  / Stock Assembly / RBU6DM



COLLAPSIBLE STOCKS

- » Proudly Designed and Made in USA
- » Stock Molded from Impact Resistant High Strength Polymer
- » Built for Heavy Duty Use with the Tightest Tolerance Controls to Provide the Most Secure Fit and Function

Black 	RBUS1BM	RBUS1BMS	RBUS2BM	RBUS2BMS	RBUS3BM	RBUS3BMS	RBUS4BM	RBUS4BMS	RBU6BM
FDE 	RBUS1DM	RBUS1DMS	RBUS2DM	RBUS2DMS	RBUS3DM	RBUS3DMS	RBUS4DM	RBUS4DMS	RBU6DM
Type	Mil-spec	Mil-spec	Mil-spec	Mil-spec	Mil-spec	Mil-spec	Mil-spec	Mil-spec	Mil-spec
	Stock Assembly	Stock Only	Stock Assembly	Stock Only	Stock Assembly	Stock Only	Stock Assembly	Stock Only	Stock Assembly
Dimensions	8.5" x 2.3" x 5.5"		8.0" x 1.5" x 5.3"		6.1" x 1.5" x 4.8"		4.3" x 1.7" x 4.8"		6.9" x 1.7" x 5.2"
Weight	23.1 oz	12.6 oz	19.7 oz	9.9 oz	16.9 oz	7.0 oz	15.5 oz	5.7 oz	16.9 oz



FIXED STOCKS



Cheek Riser Included



Storage Compartment

UTG PRO



S5 FIXED STOCK

- » Proudly Designed and Made in USA
- » Stock Molded from Impact Resistant High Strength Matte Black Polymer
- » Built for Heavy Duty Use with the Tightest Tolerance Controls to Provide the Most Secure Fit and Function
- » Compatible with Rifle-length Receiver Extension Tube, Does Not Require A2 Buttstock Spacer
- » 11" Overall Length with Ergonomic Slanted Cheek Rest and Steel Reinforced Rubberized Butt Pad
- » Integral Picatinny Rail Attaches Included 0.23" Cheek Riser and Other Accessories
- » Reversible Quick Detach Sling Swivel Housing for Left or Right Handed Shooters and Standard Sling Swivel Stud for Traditional Slings

 / AR / Stock Only / RBUS5BMS-A

A2 FIXED STOCK ASSEMBLIES

- » Stock Molded from Impact Resistant High Strength Polymer
- » (RB-T308FB) Compatible with ARMALITE[®] AR-10[®], DPMS[®] LR-308, S&W M&P[®] 10, and Other Clones

 / AR15 / Stock Assembly / RB-T469B
 / AR308 / Stock Assembly / RB-T308FB

Black 	RBUS5BMS-A	RB-T469B	RB-T308FB
Platform	AR	AR15	AR308
	Stock Only	Stock Assembly	Stock Assembly
Dimensions	10.5" x 2.0" x 5.6"	10.8" x 1.6" x 5.1"	10.8" x 1.6" x 5.1"
Weight	14.8 oz	26.4 oz	25.5 oz



ADRENALINE
PRECISION AMMO
000. GUNS. COUNTRY.
S&W Fire

ADRENALINE
5mm 15gr FMJ
50 Rounds
8CC20012

TUBES & BUFFERS



UTG PRO 

MIL-SPEC 6 POSITION RECEIVER EXTENSION TUBES & KITS

- » Extension Tube CNC Machined from 7075-T6 or 6061-T6 Aircraft Aluminum with Precisely Rolled Threads for Durable Thread Engagement with Lower Receiver
- » Tightest Tolerance Controls for a Secure Fit and Function with Various Collapsible Stocks
- » Finished in a Matte Black/Blue/Red/Bronze Hard Coat Anodization or FDE CERAKOTE®

-  / Tube Only / TLU001
-  / Tube Only / TLU001R
-  / Tube Only / TLU001B
-  / Tube Only / TLU001D 
-  / Tube Only / TLU001Z
-  / Tube Only / 7075-T6 / TLU001MS
-  / Tube Kit / TLU001-KIT
-  / Tube Kit / TLU001D-KIT 



UTG PRO 

AR308 6 POSITION RECEIVER EXTENSION TUBE

- » 6-position Mil-spec Diameter Receiver Extension Tube for AR308 Rifles
- » Extension Tube CNC Machined from 6061-T6 Aircraft Grade Aluminum with Precisely Rolled Threads for Durable Thread Engagement with Lower Receiver
- » Tightest Tolerance Controls for a Secure Fit and Function with Various Collapsible Stocks
- » Finished in a Matte Black Type III Class II Hard Coat Anodized Finish

-  / Tube Only / TLU002



CARBINE-LENGTH RECOIL BUFFERS

- » Potentially Increases Dwell Time, Eases Extraction, and Reduces Felt Recoil



- H2 / 4.6 oz / RB-T6BFH2
- H3 / 5.4 oz / RB-T6BFH3



UTG PRO 

AR PISTOL RECEIVER EXTENSION TUBE & KIT

- » 1.2" OD Receiver Extension Tube Compatible with AR15 Lower Receivers
- » Precision Machined from 7075-T6 Aircraft Aluminum with a Dry Film Lube Coated Interior for Smoother and More Reliable Cycling
- » Finished in a Matte Black Type III Class II Hard Coat Anodized Finish
- » Compatible with Standard AR15 Type Buffers and Springs
- » Compatible with Most AR Pistol Receiver Extension Tube Covers



-  / Tube Only / 7075-T6 / TLU008
-  / Tube Kit / 7075-T6 / TLU008-KIT



UTG PRO 

AR PISTOL EXTENDED RECEIVER EXTENSION TUBE & KIT

- » Precision Machined from 7075-T6 Aircraft Aluminum with a Dry Film Lube Coated Interior for Smoother and More Reliable Cycling
- » Finished in a Matte Black Type III Class II Hard Coat Anodized Finish
- » Compatible with Standard AR15 Type Buffers and Springs
- » 8.5" Extended Length and Compatible with GEAR HEAD WORKS® TAILHOOK™ MOD 1/1C Brace and or Most AR Pistol Receiver Extension Tube Covers

-  / Tube Only / 7075-T6 / TLU009
-  / Tube Kit / 7075-T6 / TLU009-KIT



A2 RECEIVER EXTENSION TUBE KIT

- » Rifle-length Extension Tube Precision Machined from 6061-T6 Aluminum and Finished in a Matte Black Anodization
- » Includes Rifle-length Extension Tube, Buffer, and Spring, A2 Stock Spacer, and Stock Screw

-  / Tube Kit / TLT-A2KT



GRIPS & HAND STOPS

A MEANS OF CONTROL.

A tailored fit. Ergonomics that join your rifle to you and fit like a glove. Take what suits you from a selection of pistol grips, hand stops, foregrips, and other control components.



JUMP TO A SERIES

 PISTOL GRIPS	146
UTG PRO® Pistol Grips	
Ultra Slim Pistol Grip	
Combat Sniper Pistol Grip	
 VERTICAL GRIPS	147
Ultra Slim Foregrips	
Super Slim Aluminum Foregrips	
Compact Polymer Foregrips	
Aluminum QD Foldable Foregrip	
D GRIP®	
Ambidextrous Foregrips	
 ULTRA SLIM ANGLED FOREGRIPS	148
 HAND STOPS	149
Angled Index Mounts	
Ultra Slim Hand Stops	
Hand Stop / Barricade Rest	

(THIRD PARTY TRADEMARKS MAY BE USED IN THIS CATALOG FOR USER CONVENIENCE TO INDICATE THE FIT OR COMPATIBILITY OF THE APPLICABLE PRODUCT.)





PISTOL GRIPS

ULTRA SLIM PISTOL GRIP

- » Compatible with Most Ambidextrous Safeties
- » Nonslip Textured Front, Back, and Side to Side Grip Paneling
- » Impact Resistant Matte Black Polymer Construction
- » Built-in Grip Storage with Hinged Floor Plate

■ / RBT-APG01B



UTG PRO[®] AMBIDEXTRIOUS CONTOURED PISTOL GRIPS

- » Compatible with Most Ambidextrous Safety Levers
- » Ergonomic Finger Grooves with Nonslip Textured Grip Serrations Provide a Solid and Repeatable Grip
- » Ergonomic Symmetrical Palm Swells Reduce Fatigue and Improve Handling Comfort
- » Built-in Storage Compartment with Removable End Cap
- » Impact Resistant Polymer Construction

■ / RBUPG01B

■ / RBUPG01D



AR15 COMBAT SNIPER PISTOL GRIP

- » Impact Resistant Matte Black Polymer Construction with Nonslip Rubberized Grip Texturing
- » Ergonomically Contoured Palm Swells, Finger Grooves, and Beavertail Back Strap
- » Built-in Grip Storage with Removable Floor Plate
- » Not Compatible with Ambidextrous Safety Levers

■ / RB-TPG172B



VERTICAL GRIPS



ULTRA SLIM FOREGRIPS

- » CNC Machined from 6061-T6 Aluminum and Finished in a Matte Black Anodization
- » Mounts Bidirectionally and Features Two Different Ergonomically Serrated Contours to Choose From
- » Lightening Cuts Reduce Overall Weight

■ / M-LOK® / MT-FGM01X
 ■ / Picatinny / MT-FGP01X



SUPER SLIM ALUMINUM FOREGRIPS

- » Precision Machined from Aircraft Aluminum Finished in a Matte Black Anodization
- » Removable Red and Blue Anodized Inserts for M-LOK® and Keymod Models Adds a Level of Personalization
- » Slim, Lightweight, Ergonomic, with Dehorned Corners and Melted Contours for a Comfortable Support Hand Grip

■ / M-LOK® / MT-FGM01
 ■ / Picatinny / MT-FGP01
 ■ / Keymod / MT-FGK01



COMPACT POLYMER FOREGRIP

- » Impact Resistant Matte Black Polymer Construction
- » Nonslip Rubberized Grip Texture
- » Lightweight, Short, and Compact Profile

■ / M-LOK® / RB-FGM01



ALUMINUM QD FOLDABLE FOREGRIP

- » Precision Machined from Aircraft Aluminum with a Matte Black Finish
- » Quick Detachable Picatinny Lever Lock Mounting Base
- » Posi-lock Cross Bolt and Spring Tensioned Locking Plate with Steel Insert for a Secure Installation
- » Removable End Cap with Waterproof Storage
- » Ergonomic Knurled Surface
- » US PAT. 8397421, US PAT. 8429843

■ / Picatinny / MNT-GRP002SQ



D GRIP®

- » Contoured Foregrip with Nonslip and Heat-resistant Rubberized Inlays
- » Ambidextrous Quick Release Deploys Foldable Impact-resistant Bipod Legs Instantly
- » Quickly Transitions from Foregrip to Bipod
- » 5.6" Foregrip Length with an 8.4" Center Height and 65° Open Angle when Bipod is Deployed
- » US PAT. 8397421, US PAT. 9169958
- » EU REG: 002245522-0001, EU REG: 002245522-0002

■ / Picatinny / MNT-DG02Q



AMBIDEXTROUS VERTICAL FOREGRIP

- » Ambidextrous Contoured Finger Grooves and Removable Grip Panels for Pressure Switch Placement
- » Internal Storage Compartment within Grip Core
- » Impact Resistant Polymer Construction

■ / Picatinny / RB-FGRP168B



AMBIDEXTROUS 5 POSITION FOLDABLE FOREGRIP

- » 5-position Foldable with Reinforced Lockup
- » Removable Ambidextrous Grip Panels for Pressure Switch Placement
- » Internal Storage Compartment within Grip Core
- » Impact Resistant Polymer Construction

■ / Picatinny / RB-FGRP170B



AMBIDEXTROUS CONTOURED VERTICAL FOREGRIP

- » Ambidextrous Contoured Finger Grooves and Palm Swell
- » Internal Storage Compartment within Grip Core
- » Impact Resistant Polymer Construction with Nonslip Rubberized Grip Texture

■ / Picatinny / RB-FGRP172B



ANGLED FOREGRIPS

ULTRA SLIM ANGLED FOREGRIPS

- » 6061-T6 Aluminum Construction Available in Matte Black, Blue, or Red Anodization, and Available for M-LOK®, Keymod, and Picatinny Modular Systems
- » Weight Reduction Lightening Cuts, Ergonomic Contours, and Serrated Front, Bottom, and Rear Faces for Added Grip Retention

M-LOK®

- / MT-AFGM01
- / MT-AFGM01B
- / MT-AFGM01R

Keymod

- / MT-AFGK01
- / MT-AFGK01B
- / MT-AFGK01R

Picatinny

- / MT-AFGP01



HAND STOPS



ANGLED INDEX MOUNTS

- » Precision Machined from 6061-T6 Aluminum and Finished in a Matte Black, Blue, or Red Anodization
- » Provides an Additional Support Hand Indexing and Retention Point
- » Reversible Design for Installation at the 3 or 9 O'clock Handguard Positions
- » Compatible with the Majority of Octagonal Handguards
- » Thumb Indexing Deck Configurable for Forward or Rearward Cant
- » Spacer Included for Adjusting Clearance with 12 O'clock Mounted Accessories and Pressure Switches
- » US PAT. 10612880

M-LOK®

- / TL-TRM01
- / TL-TRM01B
- / TL-TRM01R

Keymod

- / TL-TRK01
- / TL-TRK01B
- / TL-TRK01R

ULTRA SLIM HAND STOPS

- » 6061-T6 Aluminum Construction Available in Matte Black, Blue, or Red Anodization for M-LOK® or Keymod Modular Systems
- » Weight Reduction Lightening Cuts, Ergonomic Contours, and Serrated Front, Bottom, and Rear Faces for Added Grip Retention

M-LOK®

- / TL-HSM01
- / TL-HSM01B
- / TL-HSM01R

Keymod

- / TL-HSK01
- / TL-HSK01B
- / TL-HSK01R

KEYMOD HAND STOP/BARRICADE REST

- » 6061-T6 Aircraft Aluminum Construction with a Matte Black Finish
- » Compatible with UTG PRO® Super Slim AR15/AK Keymod Handguards
- » Ergonomic Contour Improves Firearm Handling and Speeds Up Transitions

Keymod

- / TL-HS02B

MAGAZINES



YOU CAN NEVER HAVE ENOUGH.

Having undergone numerous rounds of fully loaded drop testing, live fire testing in the thousands, and reliably holding up to fully automatic rates of fire, Leapers has the steadfast reliability shooters require out of a magazine. Take your preference of windowed or non-windowed glass fiber reinforced construction that has been adverse temperature tested for reliable function before, during, and after.



JUMP TO A SERIES

| **AK/AKM POLYMER MAGAZINE [NEW]** 152
7.62X39 / 30 Round / Windowed

| **AR POLYMER MAGAZINES** 154
5.56 / 10 Round
5.56 / 30 Round / Windowed
5.56 / 30 Round
.308 / 25 Round / Windowed

| **POLYMER MAGAZINES FOR GLOCK** 156
9mm / 15 Round
9mm / 17 Round
9mm / 33 Round
9mm / 33 Round / Windowed

[THIRD PARTY TRADEMARKS MAY BE USED IN THIS CATALOG FOR USER CONVENIENCE TO INDICATE THE FIT OR COMPATIBILITY OF THE APPLICABLE PRODUCT.]





AK/AKM WINDOWED POLYMER MAGAZINE

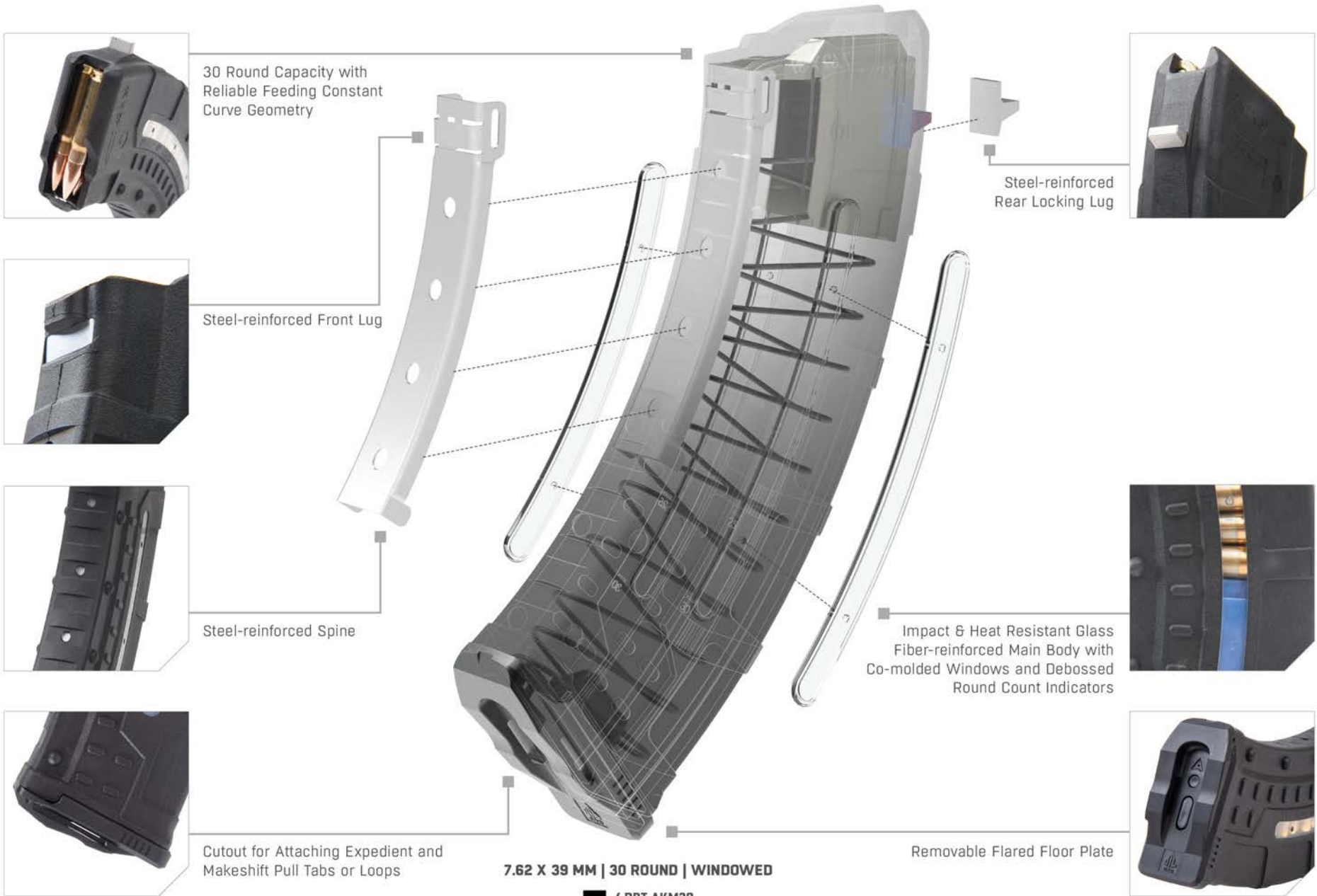



AK/AKM WINDOWED POLYMER MAGAZINE **NEW**

- » Durable Impact Resistant Long Glass Fiber-reinforced Matte Black Polymer Construction
- » Steel-reinforced Front Lug and Spine and Rear Locking Lug Provides Positive Magazine Retention while Adding Rigidity and Reducing Wear, Extending the Service Life of the Magazine
- » Reliable Feed High Visibility Blue Follower and Stainless-steel Spring
- » Co-molded Windowed 30 Round Capacity Main Body with Debossed Round Count Indicators and Reliable Feeding Constant Curve Geometry
- » Raised Bosses for Added Grip Retention
- » Easy Disassembly and Maintenance with Removable Flared Floor Plate
- » US PAT. D849178





AR POLYMER MAGAZINES



5.56 | 10 ROUND

■ / RBT-AM10



UTG PRO 

5.56 | 30 ROUND

■ / RBUAM01



5.56 | 30 ROUND | WINDOWED

■ / RBT-AM30

■ / RBT-AM30D **[NEW]**



.308 | 25 ROUND | WINDOWED

■ / RBT-DM25

POLYMER MAGAZINES

- » Durable and Impact Resistant Glass Fiber Reinforced Matte Black Polymer Construction
- » Anti-tilt High Visibility Blue Follower and High Longevity Stainless Steel Spring for Reliable Feeding
- » Easy Disassembly and Maintenance with Removable Flared Floor Plate
- » US PAT. D849178



Four-way Anti-tilt High Visibility Blue Follower and High Longevity Stainless Steel Spring for Reliable Feeding



Removable Flared Floor Plate



Fully Automatic Torture Tested



Adverse -40°F to 160°F Temperature Tested



Drop Tested



IMPACT
SPORTS

LEADER
THE BEST NEVER



POLYMER MAGAZINES FOR GLOCK®



9MM | 15 ROUND

 / RBT-GL915

9MM | 17 ROUND

 / RBT-GL917

9MM | 33 ROUND

 / RBT-GL933

9MM | 33 ROUND | WINDOWED

 / RBT-PD933

PAT. PENDING

POLYMER MAGAZINES FOR GLOCK®

- » Durable and Impact Resistant Glass Fiber Reinforced Matte Black Polymer Construction
- » Anti-tilt High Visibility Blue Follower and High Longevity Stainless Steel Spring for Reliable Feeding
- » Left and Right Side Capacity Indicators
- » Easy Disassembly and Maintenance with Removable Flared Floor Plate
- » Compatible with Reversible Magazine Release for Left or Right-handed Users

High Contrast Blue
Anti-tilt Follower

Live Fire Torture Tested

Adverse Temperature
Tested

Drop Tested

FLASHLIGHTS & LASERS



IDENTIFY WITH CERTAINTY.

It is critical to positively identify your target and what is behind it and within the immediate area. Assess and proceed accordingly with mounted and handheld solutions or ideally both for the most uncertain of times and situations. Two is one and one is none.

JUMP TO A SERIES

LASERS

160

- BULLDOT® Compact Green Laser
- Compact Green Pistol Laser
- Compact Red Laser
- Sub-compact Red Laser

FLASHLIGHT & LASER ACCESSORIES

161

WEAPON LIGHTS

162

- Sub-compact Pistol Light
- Compact Pistol Light
- Quick Detach Grip Light
- Polymer Grip Light

2-IN-1 LASER/FLASHLIGHT COMBOS

163

- Light/Red Laser Combo
- Light/Green Laser Combo
- Sub-compact Light/Red Laser Combo

(THIRD PARTY TRADEMARKS MAY BE USED IN THIS CATALOG FOR USER CONVENIENCE TO INDICATE THE FIT OR COMPATIBILITY OF THE APPLICABLE PRODUCT.)





LASERS



BULLDOT®

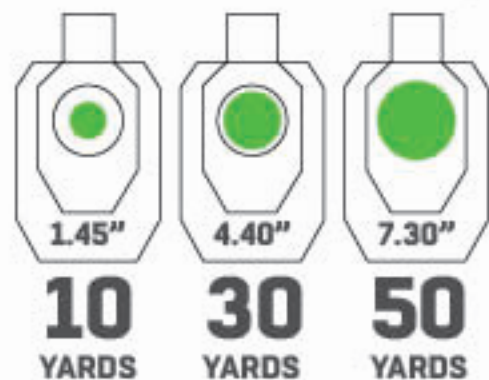

BULLDOT® COMPACT GREEN LASER

- » Expanding Beam Diameter Increases from 1.45" up to 7.3" at 50 Yards for the Eyes to Pick up Faster at Farther Distances
- » Matte Black Anodized Aluminum Construction
- » Constant On/Off Push Button Tail Cap and Pressure Switch Included

 / SCP-LS289S

	SCP-LS289S
Mount Type	Low Profile Picatinny Mount
Laser Range	328.1 yds (300 m)
Beam Diameter	1.45" (37 mm) @ 10 yds (9.1 m) 4.40" (112 mm) @ 30 yds (27.4 m) 7.3" (185 mm) @ 50 yds (45.7 m)
Dimensions	3.37" x 1.89" x 1.34" (85.5 mm x 48 mm x 34 mm)
Weight with Battery	4.35 oz (123 g)
Battery	CR2 x 1



COMPACT GREEN PISTOL LASER

- » Fits Flush on Most Compact Pistols
- » Class 3R Bright Green Laser
- » Ambidextrous Momentary/Constant On/Off Switches
- » Matte Black Anodized Aluminum Construction
- » Low Profile Picatinny Mount and Side Plate

■ / SCP-LS279S-A



COMPACT RED LASER

- » Precise Windage / Elevation Adjustment
- » Powerful Long Range Beam with Pinpoint Accuracy
- » Pressure Switch Included
- » Slide-on Picatinny Ring Mount included

■ / SCP-LS268

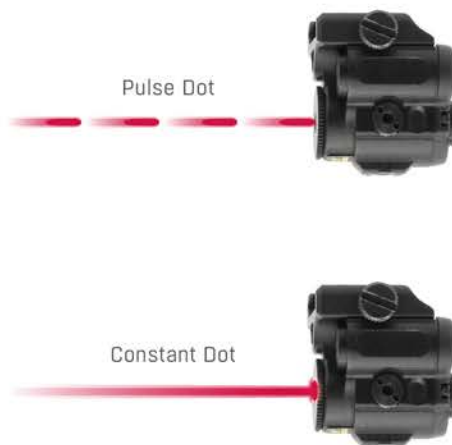

SUB-COMPACT RED LASER

- » Class 3R Bright Red Laser
- » Programmable for Constant or Pulse Dot Beam Operation
- » Matte Black Anodized Aluminum Construction
- » Sub-compact 1.19" Length
- » Low Profile Picatinny Mount and Side Plate

■ / SCP-LS200

OPTIONAL ACCESSORIES



PICATINNY OFFSET RING MOUNT

- » Compatible with 27mm, 25.4mm (1"), and 20mm Flashlight Body Diameters with Use of Included Inserts
- » Matte Black Anodized Aluminum Construction

■ / RG-FL138



M-LOK® / KEYMOD OFFSET RING MOUNTS

- » Snag-free Melted Contours and Dehorned Corners
- » Matte Black Anodized Aluminum Construction
- » Compatible with 27mm, 25.4mm (1"), and 20mm Body Diameters with Use of Included Inserts

■ / RG-FL27MC

■ / RG-FL27KC

	SCP-LS279S-A	SCP-LS200	SCP-LS268
Mount Type	Low Profile Picatinny Mount	Low Profile Picatinny Mount	Slide-on Picatinny Ring Mount
Laser Range	546.8 yds (500 m)	546.8 yds (500 m)	546.8 yds (500 m)
Beam Diameter	1.1" (28 mm) @ 16.4 yds (15 m)	1.1" (28 mm) @ 16.4 yds (15 m)	0.6" (16 mm) @ 16.4 yds (15m)
Dimensions	2.38" x 1.18" x 1.15" (60.4 mm x 30 mm x 29.3 mm)	1.19" x 1.27" x 1.28" (30.2 mm x 32.2 mm x 32.5 mm)	2.59" x 0.79" (65.8 mm x 20 mm)
Weight with Battery	2.1 oz (61 g)	1.3 oz (36 g)	1.1 oz (30g)
Battery	1/3N x 1	LR48 (AG5) x 4	LR44 x 4

	RG-FL138	RG-FL27MC	RG-FL27KC
Ring Diameter	Adaptable with Inserts		
No Insert (27 mm)	No Insert		
Insert 2 (25.4 mm)			
Compatible Model	LT-ELEDC01, LT-EL700		
Insert 1 + Insert 2 (20 mm)			

WEAPON LIGHTS



SUB-COMPACT PISTOL LIGHT

- » Fits Flush on Most Compact Pistols
- » Ambidextrous Momentary/Constant On/Off Switches
- » Flood Focus 200 Lumen Beam
- » Matte Black Anodized Aluminum Construction
- » IPX7 Waterproof Rated

■ / LT-ELP120R



COMPACT PISTOL LIGHT

- » Ambidextrous Momentary/Constant On/Off Switches
- » Removable Positional Inserts Increase Pistol Rail Compatibility
- » Flood Focus 400 Lumen Beam
- » Matte Black Anodized Aluminum Construction

■ / LT-ELP123R-A



QUICK DETACH GRIP LIGHT

- » Momentary Constant On/Off Push Button
- » Flood Focus 400 Lumen Beam
- » Matte black Anodized Aluminum Construction
- » Picatinny Quick Detach Lever Lock Mount
- » US PAT. 8397421

■ / MNT-EL228GPQ-A



POLYMER GRIP LIGHT

- » Momentary/Constant On/Off Push Button
- » Left and Right Side Toggled Momentary Only Strobe
- » Flood Focus 400 Lumen Beam, Scalable in Constant-on from 400 to 20 Lumen
- » IPX7 Waterproof Rated
- » Impact Resistant Polymer Construction
- » US PAT. D876572

■ / MT-EL223GX

	LT-ELP120R	LT-ELP123R-A	MNT-EL228GPQ-A	MT-EL223GX
Mount Type	Picatinny	Picatinny	Picatinny QD Lever Lock	Picatinny
Lumen Output	200 Lumen	400 Lumen	400 Lumen	High-400 Lumen Low-20 Lumen
Dimensions	2.98" x 1.12" x 1.13" (75.8 mm x 28.5 mm x 28.7 mm)	3.11" x 1.31" x 1.50" (79 mm x 33.3 mm x 38 mm)	2.80" x 1.77" x 5.34" (71 mm x 45.8 mm x 135.7 mm)	2.13" x 1.38" x 4.09" (54.1 mm x 35.1 mm x 103.9 mm)
Weight (w/Battery)	2.6 oz (73 g)	3.5 oz (100.2 g)	12 oz (340.2 g)	6.6 oz (187.1 g)
Bulb Type	20 mm LED IRB	24 mm LED IRB	26 mm LED IRB	23 mm LED IRB
Focus	Flood	Flood	Wide Angled Flood	Wide Angled Flood
Battery	CR2 x 1	CR2 x 1	CR123A x 2	CR123A x 2
Battery Life	1 hr	1 hr	3 hrs	High - 3 hrs Low - 24 hrs

2-IN-1 LASER/FLASHLIGHT COMBOS



LIGHT/RED LASER COMBO

- » 400 Lumen Flashlight with 3 Hour Runtime and Dual-function Push-button Momentary On/Off and Constant Twist On/Off Activation
- » Class 3R Type Red Laser with Push-button On/Off and 4-point Retention Erector Return Springs for Reliable Zero Hold
- » Adjustable Rotating Laser Bracket Provides 10 Mounting Positions around the Circumference of the Light
- » Patented Quick-detach Lever Lock Picatinny Mount
- » Optional Flashlight and Laser Pressure Switches Included
- » US PAT. 8397421

■ / LT-ELP380-A

LIGHT/GREEN LASER COMBO

- » 400 Lumen Flashlight with 3 Hour Runtime and Dual-function Push-button Momentary On/Off and Constant Twist On/Off Activation
- » Bright Green Laser with Push-button On/Off and 4-point Retention Erector Return Springs for Reliable Zero Hold
- » Adjustable Rotating Laser Bracket Provides 10 Mounting Positions around the Circumference of the Light
- » Patented Quick-detach Lever Lock Picatinny Mount
- » Optional Flashlight and Laser Pressure Switches Included
- » US PAT. 8397421

■ / LT-ELP390-A

SUB-COMPACT LIGHT AND RED LASER

- » 120 Lumen Flood Focus Flashlight with Bright Red Laser Powered Off a Single CR2 Battery for a Combined Run Time of 45 Minutes
- » Included Quick-insert Pressure Switch is User Configurable for Simultaneous or Standalone Operation of Light and Laser
- » Integral Weatherproof Plug Replaces Quick-insert Pressure Switch When Not in Use
- » Low Profile Design Mounts Close to Handguard and Bore of Firearm

■ / LT-ELP28R

	LT-ELP380-A	LT-ELP390-A	LT-ELP28R
Mount Type	Picatinny QD Lever Lock	Picatinny QD Lever Lock	Picatinny
Lumen Output	400 Lumen	400 Lumen	120 Lumen
Dimensions	5.12" x 1.92" x 1.27" (130 mm x 48.8 mm x 32.3 mm)	5.35" x 2.24" x 1.28" (136 mm x 56.8 mm x 32.5 mm)	2.04" x 1.97" x 1.69" (51.8 mm x 50 mm x 43 mm)
Weight (w/Battery)	7.3 oz (209 g)	8.6 oz (243 g)	2.9 oz (83 g)
Bulb Type	23 mm LED IRB	23 mm LED IRB	16 mm LED IRB
Focus	Flood	Flood	Flood
Laser Range	546.8 yds (500 m)	546.8 yds (500 m)	164 yds (150 m)
Beam Diameter	0.63" (16 mm) @16.4 yds (15 m)	0.7" (17.8 mm) @16.4 yds (15 m)	1.1" (28 mm) @16.4 yds (15 m)
Flashlight Battery	CR123A x 2	CR123A x 2	CR2 x 1
Flashlight Battery Life	3 hrs	3 hrs	1 hr
Laser Battery	LR44 x 4	CR2 x1	N/A
Laser Battery Life	1.3 hrs	3.3 hrs	45 mins

ACCESSORIES & TOOLS



UP FOR THE TASK AT HAND.

Range bag essentials. Work bench must-haves. Tools of the trade. Even small odds and ends you end up identifying a need for to get your rifle feeling and equipped just right.



JUMP TO A SERIES

	M-LOK® ARCA RAILS [NEW]	166
	RAIL SECTIONS & COVERS	168
	QD SLING SWIVELS & ADAPTORS	169
	AR ACCESSORIES	170
	Oversized Bolt Catch	
	Ambidextrous 45/90 Safety Selectors	
	Oversized Trigger Guards	
	Ambidextrous Extended Magazine Releases	
	Quick Install Dust Cover	
	MUZZLE DEVICES & GAS BLOCKS	171
	CZ SCORPION ACCESSORIES	172
	Charging Handles	
	Safety Selectors	
	TOOLS & MAINTENANCE	173

[THIRD PARTY TRADEMARKS MAY BE USED IN THIS CATALOG FOR USER CONVENIENCE TO INDICATE THE FIT OR COMPATIBILITY OF THE APPLICABLE PRODUCT.]





UTG PRO® M-LOK® ARCA RAILS



3.1" LENGTH

■ / TLUMA01



7.9" LENGTH

■ / TLUMA02



9.4" LENGTH

■ / TLUMA03



14.2" LENGTH

■ / TLUMA04

UTG PRO® NEW UTG PRO® M-LOK® ARCA RAILS

- » Proudly Designed and Made in USA
- » Contoured to Prevent Snagging and Discomfort When Shooting Unsupported
- » CNC Machined 7075-T6 Aluminum Finished in a Matte Black Anodize
- » M-LOK® Interface Spaced for Installation in Complete Slots or in Between Adjacent Slots
- » Laser Engraved Positional Indicator Markings
- » Forms a Continuous Rail when Multiple Rails are Installed in Line
- » Compatible with Standard ARCA, R-LOCK, and MRAS QD Adaptors and Mounts

Black ■	TLUMA01	TLUMA02	TLUMA03	TLUMA04
Length	3.1"	7.9"	9.4"	14.2"
Weight	0.88 oz	2.29 oz	2.88 oz	3.83 oz
Material	7075-T6 Aluminum	7075-T6 Aluminum	7075-T6 Aluminum	7075-T6 Aluminum
Mount type	M-LOK®	M-LOK®	M-LOK®	M-LOK®



RAIL SECTIONS & COVERS

UTG PRO[®] M-LOK[®] PICATINNY RAIL SECTIONS



3-slot / MTURS10S



7-slot / MTURS10M



4-slot / MTURS09S



8-slot / MTURS09M

G36 PICATINNY RAIL SETS



Two 3.87" Length Rails with 7 Picatinny Slots

 / MNT-P501 (Set of 2)



One 6.08" Length Rail with 13 Picatinny Slots and Two 3.87" Length Rails with 7 Picatinny Slots

 / MNT-P503 (Set of 3)



Three 6.08" Length Rails with 13 Picatinny Slots

 / MNT-P505 (Set of 3)



M-LOK[®] ANGLED PICATINNY MOUNT

- » Angled Offset Optimally Positions Lights, Optics, or Other Accessories at the 11 or 1 O'clock Positions on Most Handguards
- » Durable Matte Black Anodized Aluminum Construction
- » Removable Spacer Adjusts Clearance to Fit Various Handguard Profiles

 / MT-MP45



LOW PROFILE M-LOK[®] RAIL PANEL COVER

- » 3.15" in Length, Slim, Lightweight, and Securely Installs via Two M-LOK[®] Screws and Nuts
- » Nonslip Textured Design Provides a Sure Grip Every Time
- » Molded from Durable Impact and Heat Resistant Polymer with a Rubberized Overmold

 / RB-HP30M (Set of 4)



QD SLING SWIVELS & ADAPTORS

PICATINNY SLING SWIVEL MOUNT WITH 1.25" LOOP



- » Precision Machined Aircraft Aluminum and Steel Construction with a Matte Black Finish
- » Solid Steel 1.25" Sling Loop Compatible with Most Slings on the Market

■ / TL-SWMTP01



UTG PRO[®] SLING SWIVEL ADAPTORS

- » Precision Machined from 6061-T6 Aircraft Aluminum with a Matte Black Anodization
- » Accepts Any Standard Quick Detach Sling Swivel with 0.37" Diameter Swivel Stud
- » Designed with Quarter Turn Rotational Over Travel Stops to Restrict Swivel Movement

■ / M-LOK[®] / TLUSW001
 ■ / Keymod / TLUSW002

ANGLED QD SLING SWIVEL PICATINNY ADAPTOR



- » Accepts Any Standard Quick Detach Sling Swivel with 0.37" Diameter Swivel Stud
- » Precision Machined from Aircraft Aluminum with a Matte Black Finish
- » Low Profile and Lightweight Design with 45° Offset
- » Designed with Quarter-turn Rotational Over Travel Stops to Restrict Swivel Movement

■ / TL-SWPM01



PICATINNY/KEYMOD QD SLING SWIVEL ADAPTOR

- » Compact and Lightweight Design Adaptable for Installation on Both Picatinny or Keymod Rails
- » Accepts Any Standard Quick Detach Sling Swivel with 0.37" Diameter Swivel Stud
- » Precision Machined from Aircraft Aluminum with a Matte Black Finish

■ / TL-SWPK01

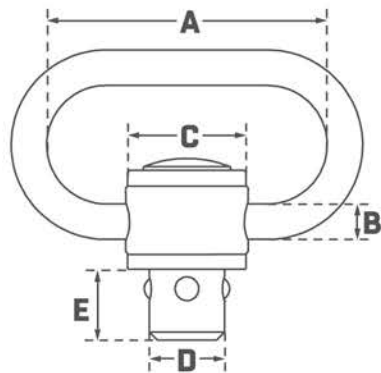

STEEL QD SLING SWIVELS

High Strength Steel Construction with a Matte Black Finish



1.09" LOOP



1.25" LOOP



1.29" C-SHAPE LOOP



1.38" LOOP



1.41" LOOP

	TL-QDSW08A	TL-QDSW08B	TL-QDSW08C	TL-QDSW18	TL-QDSW38
A-Loop Width	1.09"	1.25"	1.29"	1.38"	1.41"
B-Loop Thickness	0.13"	0.13"	0.13"	0.17"	0.18"
C- Push Button Diameter	0.47"	0.47"	0.47"	0.60"	0.64"
D-Stud Diameter	0.37"	0.37"	0.37"	0.37"	0.37"
E-Stud Height	0.35"	0.35"	0.35"	0.37"	0.35"



AR ACCESSORIES

AR15 LOWER UPGRADE KIT

■ / TLT-TKS01



OVERSIZED BOLT CATCH

- » Serrated and Oversized Bolt Release and Extended Catch for Easier Reach and Manipulation
- » Steel Construction Finished in Matte Black
- » Includes Installation Hardware



■ / TLT-TKSBC

OVERSIZED TRIGGER GUARD

- » Enlarged Open Geometry Provides Easier and Safer Access to Trigger Particularly when Wearing Gloves
- » Aluminum Construction Finished in Matte Anodization
- » Includes Installation Tool and Hardware



■ / TLT-TKSTG
 ■ / TLT-TKSTGB
 ■ / TLT-TKSTGR

QUICK INSTALL DUST COVER

- » Matte Black Impact and Heat Resistant Polymer Construction with Steel Spring-loaded Detent
- » Patented Tool-free Design Quickly Installs Without Having to Remove The Handguard Prior
- » Compatible with all .223/5.56 Mil-spec and Most Billet Upper Receivers
- » US PAT. 10393467



■ / RBT-TKSDC

AMBIDEXTROUS 45/90 SAFETY SELECTOR

- » Reversible Short and Long Oversized Levers Finished in a Matte Anodization
- » Aluminum and Steel Construction
- » 45° or 90° Throw Configurable
- » Includes Installation Tool, Hardware, Detent, and Detent Spring



■ / TLT-TKSLT
 ■ / TLT-TKSLTB
 ■ / TLT-TKSLTR

AMBIDEXTROUS EXTENDED MAGAZINE RELEASE

- » Features Oversized and Extended Left and Right Side Releases for Easier Reach and Manipulation
- » Aluminum and Steel Construction Finished in a Matte Anodization
- » Includes Installation Tool and Hardware



■ / TLT-TKSMR
 ■ / TLT-TKSMRB
 ■ / TLT-TKSMRR

AR15 QD RECEIVER END PLATE

- » Compatible with Standard Mil-spec AR15 Lower Receiver
- » Solid Steel Construction with a Matte Black Finish
- » Accepts Any Standard Quick Detach Sling Swivel with 0.37" Diameter Swivel Stud
- » Designed with Quarter Turn Rotational Over Travel Stops to Restrict Swivel Movement



■ / TL-T6TD03

MUZZLE DEVICES & GAS BLOCKS



WWW.LEAPERS.COM | SINCE 1992



9MM | 1/2"X28
■ / TLUMD03



.223/5.56 | 1/2"X28
■ / TLUMD01



.223/5.56 | 1/2"X28
■ / TLUMD02

UTG PRO MUZZLE BRAKES

- » Steel Construction Finished in Black Nitride
- » 1/2"-28 UNEF Thread Compatible, Crush Washer Included
- » Gas Dispersion Porting Reduces Felt Recoil and Muzzle Rise
- » Up to 50% Recoil Reduction



AR15 MICRO GAS BLOCK

- » Low Profile, Fits Underneath Most Free Float Handguards
- » Precision Machined Steel to Exacting Tolerances for .750" Diameter Barrels at the Gas Port
- » Durable and Corrosion Resistant Manganese Phosphate Finish
- » Includes Gas Tube Roll Pin, Serrated Self-locking Set Screws, and Installation Tool

■ / MNT-ARMGB01



AR15 BLANK FIRING ADAPTOR

- » Precision Machined High Strength Steel Construction
- » Color Coated for Protection and Discernibility
- » Reinforced Frame Surpasses Military Standards
- » Ideal for Law Enforcement and Military Training
- » User Friendly Bolt Ring for Simple Installation and Removal

■ / MNT-16AD2-C



CZ® SCORPION ACCESSORIES



CHARGING HANDLE FOR CZ® SCORPION™ EVO 3

- » Reversible for Left or Right Side Drop-in Installation
- » Extended and Partially Serrated Handle with Dehorned Corners and Melted Contours
- » Steel Guide with 6061-T6 Aluminum Handle Finished in a Matte Black, Red, or Blue Anodization
- » Compatible with Both Pistol and Carbine Models

- / TLT-CSCH01
- / TLT-CSCH01B
- / TLT-CSCH01R



SAFETY SELECTORS FOR CZ® SCORPION™ EVO 3

- » Machined from 6061-T6 Aluminum Finished in a Matte Black, Red, or Blue Anodization
- » Drop-in Installation, No Permanent Modification Required
- » Compatible with Both Pistol and Carbine Models
- » Extended Selectors with Dehorned Corners and Melted Contours
- » Ergonomic Thumb Index for Ease of Manipulating Safety On and Off

- / TLT-CSSLT01
- / TLT-CSSLT01B
- / TLT-CSSLT01R

TOOLS & MAINTENANCE



AR15/AR308 ARMORER'S MULTI-FUNCTION COMBO WRENCH

- » Provides the Tools to Install and Remove Parts Often Replaced and or Reinstalled on Both the AR15 and AR308 Platforms such as: Standard A2 Flash Hider, Delta Ring Assembly, Rifle Length Buffer Tube, Carbine Buffer Tube Castle Nut, and More
- » Steel Construction with Wear Resistant Finish for Long Lasting Durability

■ / TL-ARWR01



MINI AR15 ARMORER'S WRENCH

- » Provides the Tools to Install and Remove Parts Often Replaced and or Reinstalled on the AR15 Platforms such as: Standard A2 Flash Hider, Delta Ring Barrel Nut Assembly, Rifle Length Buffer Tube, Carbine Buffer Tube Castle Nut, and More
- » Steel Construction with Wear Resistant Finish for Long Lasting Durability

■ / TL-ARWR02

.223/5.56 CLEANING KIT

- » Includes a 5-piece Extension Steel Cleaning Rod with Adaptor, Patch Loop, Bronze Bore Brush, Chamber Brush, Double-Ended Nylon Utility Brush, ½ oz Oil Bottle, and Cleaning Patches
- » All Parts Conveniently Store within the Included OD Green Nylon Pouch with Belt Loop and ALICE Clip Attachment Point and Featuring Two Hook-and-loop Closure Pockets and External Snap Button Flap

■ / TL-A041



9MM PISTOL CLEANING KIT

- » Conveniently Stows Away in Any Range Bag in Its Compact Polymer Case (4.63"x2.88"x1.50")
- » Kit Includes an 8-32 Threaded Copper Alloy Cleaning Rod with the Following Threaded Cleaning Accessories: Patch Loop, Bronze and Nylon Brush, and a Cotton Mop

■ / TL-CLP9MMKT



CHAMBER SAFETY FLAG

- » Bright Red for High Visibility and Reliable Confirmation of an Unloaded Firearm
- » Molded from Impact Resistant Polymer with Reinforced Head for Maximum Durability
- » Ideal for Cold Range Use and Mass Produced Firearms

■ / RB-CSF06 (Set of 6)



AK/SKS FRONT SIGHT TOOL

- » An Essential Tool for Making Fine Front Sight Post Windage and Elevation Adjustments
- » Compatible with AK, SKS, MAK, and SLR95 Pattern Rifles

■ / SCP-WEA05



UNIVERSAL SHOTGUN FOREND WRENCH

- » Nickel Plated Steel Construction
- » User Friendly with Ergonomic Handles for Easy Forend Removal and Installation
- » Compatible with REMINGTON® 870™, MOSSBERG® 500A/C, 835, and Other Clones

■ / TL-SHWR01



GUN CASES



BRING MORE THAN ONE GUN.

Zip up those cases, square away the ammo, and do not forget the magazines. Transport your range toys and your work horses with Leapers.



JUMP TO A SERIES

RAPID DEPLOYMENT PACKS	176
Responder Sling Pack 34"	
Rapid Sling Packs 30" / 34"	
RC CASE	178
42"	
MC CASE	180
34" / 32" / 25"	
KEEP-IT-SIMPLE KIS CASE	182
38" / 28"	
PISTOL CASES	184
Competition Shooter's Double Pistol Case	
Double Pistol Case	
Single Pistol Case	
Discreet Handgun Case	

(THIRD PARTY TRADEMARKS MAY BE USED IN THIS CATALOG FOR USER CONVENIENCE TO INDICATE THE FIT OR COMPATIBILITY OF THE APPLICABLE PRODUCT.)





RAPID DEPLOYMENT PACKS



RESPONDER SLING PACK

- » Front Zipper Pocket Features MOLLE Webbing and Tool Pouch
- » Padded Barrel Catch Keeps Muzzle Secured and Protected During Transportation
- » Quick Deployment Pull Tab for Rapid Deployment
- » Padded Back Panel for Comfortable Carry and Back Support
- » Dual #10 Lockable Zippers

■ / 34 inch / PVC-PSP34B



RAPID SLING PACKS

- » Discreet Overall Shape and Appearance
- » Padded Barrel Catch Keeps Muzzle Secured and Protected During Transportation
- » Features Top and Bottom Wraparound Carry Handles and Quick Deployment Pull Tabs
- » Dual #10 Lockable Zippers
- » Removable Padded Center Divider Separates and Protects Firearms when Transporting Two Together

- / 34 inch / PVC-PSP34BX
- / 34 inch / PVC-PSP34BN
- / 30 inch / PVC-PSP30BN
- / 34 inch / PVC-PSP34BG

	Black ■	PVC-PSP34B	PVC-PSP34BX	
	Black / Navy ■		PVC-PSP34BN	PVC-PSP30BN
	Black / Gray ■		PVC-PSP34BG	
Main Compartment Dimensions		34" x 15"	34" x 13"	30" x 12"
Material		Polyester	Polyester	Polyester
Density		1200D	900D	900D



RC CASE



OPERATIONS RC GUN CASE

- » Three Front Detachable MOLLE Pouches Perfect for Magazines, Ammo, and Other Shooting Gear
- » Inner Hook-and-loop Pockets can Store Pistol, Cleaning Equipment, and Targets
- » Secondary Compartment Contains Additional MOLLE Webbing
- » Removable Padded Center Divider
- » Fully Adjustable Hook-and-loop Retention Straps and Padded Corner Pockets
- » Rigid Back Spine for Improved Durability and Shape Integrity
- » Dual #10 Lockable Zippers

■ / 42 inch / PVC-RC42B-A

Black ■	PVC-RC42B-A
Main Compartment Dimensions	42" x 13"
Material	Polyester
Density	900D



HOMELAND SECURITY MC GUN CASES



25 INCH CASE

32/34 INCH CASES



25 INCH CASE



32 INCH CASE



34 INCH CASE



HOMELAND SECURITY MC GUN CASES

- » Durable 600D Polyester Construction
- » Padded Main Compartment with User Configurable Retention Straps
- » Outer Compartment Stores Other Essential Gear and Ammunition
- » Features D-ring Wall Hanger, Carry Handle, Adjustable Shoulder Strap, Morale Patch Panel, and Dual #10 Lockable Zipper Closures

- / 34 inch / PVC-MC34B-A
- / 32 inch / PVC-MC32B-A
- / 25 inch / PVC-MC25B-A

	Black ■	PVC-MC34B-A	PVC-MC32B-A	PVC-MC25B-A
Main Compartment Dimensions		34" x 12"	32" x 12"	25" x 12"
Material		Polyester	Polyester	Polyester
Density		600D	600D	600D

KEEP-IT-SIMPLE



KIS GUN CASES | KEEP-IT-SIMPLE



38 INCH CASE

28 INCH CASE

KIS GUN CASES | KEEP-IT-SIMPLE

- » Two Zippered Outer Pockets Store Other Essential Gear, Ammunition, and Paper Targets
- » Features Wall Hanger Loops, Carry Handle, Adjustable Shoulder Strap, Morale Patch Panel
- » Dual #8 Lockable Zippers

- / 38 inch / PVC-KIS38B2
- / 28 inch / PVC-KIS28B

Black ■	PVC-KIS38B2	PVC-KIS28B
Main Compartment Dimensions	38" x 11"	28" x 12.5"
Material	Polyester	Polyester
Density	600D	600D



PISTOL CASES



COMPETITION SHOOTER'S DOUBLE PISTOL CASE

- » Inside Large Hook-and-loop Panel Complete with 2 Universal Detachable Holsters
- » Padded Center Pouch Provides Pockets of Various Sizes to Store Various Shooting Essentials
- » Exterior Equipped with Two Miscellaneous Pockets with Zippered Closures
- » Additional Hook-and-loop Panel for Attaching Patches
- » Elastic Bands for Pistol Magazines, Flashlights, Suppressors, and Other Equipment
- » Dual #8 Lockable Zippers

■ / 11.5 x 9.5 inch / PVC-PC05B



DOUBLE PISTOL CASE

- » Fully Padded Interior
- » 6 Universal Magazine Pouches
- » Additional Outer Accessory Pocket
- » Wraparound Carry Handles
- » Dual #10 Lockable Zippers

■ / 13 x 10 inch / PVC-PC02B

SINGLE PISTOL CASE

- » Fully Padded Interior
- » 5 Universal Magazine Pouches
- » Additional Outer Accessory Pocket
- » Wraparound Carry Handles
- » Dual #10 Lockable Zippers

■ / 11 x 8 inch / PVC-PC01B

DISCREET HANDGUN CASE

- » Universal Design Compatible with Most Sub-compact Pistols or Revolvers
- » Padded Construction with Reinforced Double Stitching for Added Durability
- » Integral Spare Magazine Pouch
- » Supported Front and Back Panels for Improved Durability and Shape Integrity
- » Dual #8 Lockable Zippers

■ / 5 x 7 inch / PVC-PC380

Black ■	PVC-PC05B	PVC-PC02B	PVC-PC01B	PVC-PC380
Main Compartment Dimensions	11.5" x 9.5"	13" x 10"	11" x 8"	5" x 7"
Material	Polyester	Polyester	Polyester	Polyester
Density	900D	1680D	1680D	1680D

TACTICAL GEAR



PREP FOR ANYTHING.

Get your gear in check with Leapers. Whether heading to an after-work range session, spending the weekend outdoors, or its open season focus more time in your element and less time hassling last minute.



JUMP TO A SERIES

TRAIL SEEKER, TRAIL CAM BACKPACK	188
OVERBOUND PACK	190
ALL-IN-ONE RANGE/UTILITY GO BAG	192
HOLSTERS	194
IWB Belt Holster [NEW]	
Belt Holster	
Ambidextrous Belt Holster	
Horizontal Shoulder Holster	
Vertical Shoulder Holster	
Universal Ankle Holster	
Special OPS Tactical Tight Holster	
LONG GUN SLINGS & BELT	196
TACTICAL VESTS	197

(THIRD PARTY TRADEMARKS MAY BE USED IN THIS CATALOG FOR USER CONVENIENCE TO INDICATE THE FIT OR COMPATIBILITY OF THE APPLICABLE PRODUCT.)





TACTICAL GEAR

TRAIL SEEKER



TRAIL SEEKER, TRAIL CAM BACKPACK



- » Padded Modular Main Compartment with User-configurable Hook-and-loop Dividers and Shelf Inserts
- » 28 Liter Total Compartmental Capacity Easily Stores Up to 9 Trail Cams



- » Removable SD Card Holder Included and Holds up to 24 SD Cards



- » Miscellaneous Pouches, Elastic Loops, and Zippered Pockets Provide Ample Storage Space for Other Related Accessories
- » Spiked Rubber Bottom



- » Comfortable and Wearable Ergonomics Include Breathable Padded and Moisture Wicking Back Panel and Shoulder Straps
- » Adjustable Chest and Waist Straps for Added Close Body Retention when on the Move

TRAIL SEEKER, TRAIL CAM BACKPACK

- » Durable Water-resistant 600D Polyester Construction with Reinforced Heavy Gauge Stitching and Spiked Rubber Bottom
- » Padded Modular Main Compartment with User-configurable Hook-and-loop Dividers and Shelf Inserts
- » 28 Liter Total Compartmental Capacity Easily Stores Up to 9 Trail Cams
- » Miscellaneous Pouches, Elastic Loops, and Zippered Pockets Provide Ample Storage Space for Other Related Accessories

■ / PVC-GC01

Black ■	PVC-GC01
Dimensions	14" x 9" x 19"
Material	Polyester
Density	600D
Capacity	28 Liter

OVERBOUND PACK



OVERBOUND PACK



OVERBOUND PACK

- » Durable 600D Nylon Construction with Reinforced Heavy Gauge Stitching
- » Optimized Space Saving Compartments, Pockets, and Layout Gets You to the Things You Need
- » Modular Outer MOLLE and Hook-and-loop Panels for Attaching Other Gear and Morale Patches
- » Rear Back Panel Compartment Easily Accessible from the Left or Right Side for Quick Storage and Use Items

■ / PVC-P836GM



Ergonomic, Contoured, and Padded Shoulder Straps



Luggage Strap

Gun Metal ■	PVC-P836GM
Dimensions	12" x 6" x 18"
Material	Nylon
Density	600D
Capacity	28 Liter

ALL-IN-ONE RANGE BAG



ALL-IN-ONE RANGE BAG



8 Removable, Thickly Padded, and Adjustable Internal Dividers, 2 Removable Pistol Cases, and 1 Brass Bag Included



Open Top with Clear Zippered Pocket and Lockable Zipper Closure for Full and Easy Access to Main Compartment



Zippered Side Pocket and Retention Adjustable Water Bottle Pouch



Thickly Padded Bottom with Four Rubber Foot Pads Prevents the Bottom of the Bag from Abrasion



Removable Pistol Cases and Brass Bag included; Perfect for Competition and Recreation

ALL-IN-ONE RANGE/UTILITY GO BAG

- » Tough PVC Coated Material, Reinforced Stitching, Heavy Duty Zippers, and Padded Pockets
- » Ample Storage Capacity and Layout Designed to Meet Different Application Demands for Simple Organization
- » Zippered Side Pocket for Ammunition, Magazines, and Other Accessories via 8 Elastic Loops
- » Padded Front and Back Zippered Pockets with MOLLE Webbing
- » Fully Adjustable Shoulder Strap and Wraparound Carry Handles

■ / PVC-P365B

Color	Black ■	Model	PVC-P365B
Dimensions	21" x 9" x 8"		
Material	Polyester		
Density	600D		



HOLSTERS



IWB BELT HOLSTER **NEW**

- » Right-handed Inside-the-waistband (IWB) Carry with Elastic Hook-and-loop Release
- » Reinforced Padded Polyester Construction with Steel Belt Clip
- » Fits Belts up to 1.5"
- » Compatible with Most Sub-compact and Micro 9 Pistols

■ / Right Handed / PVC-H389B



BELT HOLSTER

- » Designed to Fit most Compact to Full Size Pistols
- » Adjustable Holster Strap Retention with Quick Release Buckle
- » Built-in Magazine Pouch
- » Durable Hook-and-loop Belt Retention Strap

■ / Right Handed / PVC-H270B



AMBIDEXTROUS BELT HOLSTER

- » Universal Design with Open Bottom to Fit a Wider Variety of Compact to Full Size Pistols
- » Adjustable Hook-and-loop and Snap-on Thumb Break Retention Strap

■ / Ambidextrous / PVC-H288B



VERTICAL



HORIZONTAL

SHOULDER HOLSTERS

- » Universal Fit Compatible with Most Compact to Full Size Pistols
- » Fully Adjustable Design Fits Most Body Types
- » Reinforced Stitching and Seams
- » Inverted Dual Magazine Pouch with Hook-and-loop Closures

/ Horizontal / Ambidextrous / PVC-H170B
 / Vertical / Ambidextrous / PVC-H175B



UNIVERSAL ANKLE HOLSTER

- » Universal and Ambidextrous
- » Position Adjustable Retention Strap, Extended Muzzle Guard, and Formfitting Dual layer Elastics for Greater Compatibility Across Most J-frame, Subcompact, and Compact Pistols
- » Synthetic Panel Overlay Guards Against Compression and Unwanted Ingress into the Trigger Guard

/ Ambidextrous / PVC-H191B



- » Position Adjustable Retention Strap

- » Adjustable Hook-and-loop Calf and Ankle Straps
- » 11.5" Overall Height with Adjustable Ankle Circumference from 11.5" - 15.5"
- » Calf Circumference from 11.5" - 19"



- » Padded, Breathable, and Reinforced Neoprene Construction



SPECIAL OPS TACTICAL THIGH HOLSTERS

- » Fits Most Compact to Full Size Pistols
- » Fully Adjustable Nonslip Leg Strap with Buckle Closure and Cushioned Wraparound Main Body
- » Height Adjustable Belt Strap with Buckle Closure
- » Adjustable Thumb Strap Retention with Quick Release Buckle
- » Built-in Spare Magazine Pouch

/ Right Handed / PVC-H178B
 / Left Handed / PVC-H178BL



- » Hook-and-loop Strap Pulls Holster Towards Thigh for a Close-to-body Fit



LONG GUN SLINGS & BELT



BOLLA® 2 TO 1 POINT CONVERSION QD SLING

- » Adjustable in Length from 42"-58", Matte Black 1.2" Width Polyester Webbing with Portion of Sling Padded for Comfort
- » Lightweight Steel Slider with Oversized D-ring and Pull Strap Intuitively and Quickly Adjusts Sling Tension by Pulling Forward to Increase Slack and Length and Rearward to Decrease
- » Steel QD Sling Swivels and an Ambi. QD Swivel Housing Easily Converts the Sling from 2 Point to 1 Point Configuration

■ / Two to One Point / PVC-GB508B



QD SLING SWIVEL SINGLE POINT BUNGEE SLING

- » Heavy Duty 1.5" Quick Adjustable Polyester Webbing and Elastic Construction
- » Steel Push Button Quick Detach Sling Swivel Attachment for Quick Installation and Removal
- » Durable Bungee System Reduces Fatigue by Relieving the Felt Weight of the Firearm from the User's Shoulder
- » Inner Length Adjustable from 42" to 58" to Accommodate Various Body Types and Gear

■ / Single Point / PVC-GB507B



UNIVERSAL RIFLE SLING

- » Durable 1.5" Width Webbing with Non-slip Grip Texture Applied to Keep Sling from Unintentionally Shifting
- » Traditional Sling Loops Securely Fasten to a Wide Variety of Different Firearms
- » Adjustable Length from 44" to 52" to Accommodate Various Body Types and Gear

■ / Two Point / PVC-GB605



LAW ENFORCEMENT & SECURITY DUTY BELT

- » Detachable Belt Keepers
- » Hook-and-Loop Adjustment (30" - 52" Waist)
- » Two Horizontal Pistol Magazine Pouches
- » Heavy Duty Quick Release Buckle

■ / PVC-B950-A

547 LE TACTICAL VESTS



547 LE TACTICAL VESTS

- » Breathable Materials & Construction Releases Moisture and Heat
- » Padded Shoulder Pad and Guard Absorbs Recoil and Aids in Consistent Stock Placement
- » Large ID Pouch with Detachable Elastic Shot Shell Carrier
- » Dedicated Communication Pouch
- » 3 Double Stack Pistol Magazine Pouches and 2 Detachable Horizontal Magazine Pouches
- » Single Quick Reload Rifle Magazine Pouch
- » Detachable Right-handed Cross-draw Holster Interchangeable with Included Double Rifle Magazine Pouch
- » Reinforced Drag Handle
- » Heavy Duty Back Panel Webbing for Attaching Additional Gear
- » One Size Fits Most with Straps Adjustable in Girth up to a 54" Waist

/ Right Handed / PVC-V547BT
 / Left Handed / PVC-V547BL

Black 	PVC-V547BT	PVC-V547BL
Adjustable Height	22" - 25"	22" - 25"
Adjustable Girth	40" - 54"	40" - 54"
Adjustable Belt Length	44" - 52"	44" - 52"
Material	Polyester	Polyester
Density	1680D	1680D
Handedness	Right Handed	Left Handed





LEAPERS.COM

LEAPERS®

MICHIGAN USA

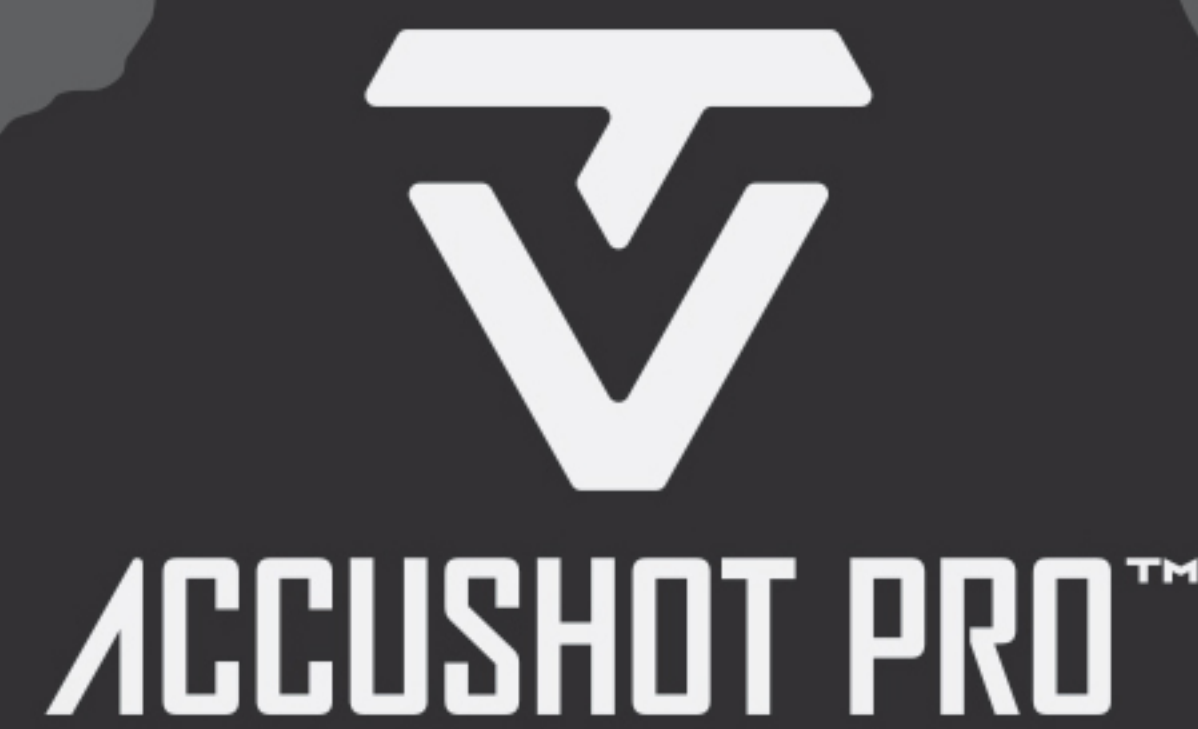

USA HEADQUARTERS UTG PRO PLANT

ADDRESS 32700 CAPITOL STREET,
LIVONIA, MI 48150 U.S.A.
TELEPHONE (734) 542-1500
FAX (734) 542-7095
E-MAIL OFFICE@LEAPERS.COM
WEBSITE WWW.LEAPERS.COM

UTG EUROPE

AM BAHNDAMM 7,
63683 ORTENBERG, GERMANY
+49 (0) 6041-969686 0
+49 (0) 6041-969686 66
INFO@UTGEUROPE.COM
WWW.UTGEUROPE.COM

UTG CHINA

NO. 868 XINGYU ROAD,
NANTONG, JIANGSU, CHINA
+86 (0) 513 81503888
+86 (0) 513 81503588
OFFICE@LEAPERS.COM
WWW.UTG.COM.CN

UTG TAIWAN

NO.36, QUNYI RD., ZHUNAN TOWNSHIP,
MIAOLI COUNTY 350, TAIWAN (R.O.C.)
+886 (0) 37 580333
+886 (0) 37 580337
CONSEIL@UTG-TAIWAN.COM
WWW.UTGTAIWAN.COM



LEAPERS



UTGLEAPERS

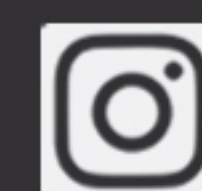

LEAPERS_INC