

A close-up photograph of a person wearing a grey tactical cap and a headset, aiming a black rifle. The rifle's stock is a UTG Pro model, with the brand name visible on the cheek rest. The person is wearing a dark long-sleeved shirt. The background is a blurred outdoor setting with green foliage.

# STOCKS, BUFFERS & TUBES

## ADD THE FINISHING TOUCH

You found and collected enough spare parts from deep within the confines of your basement to complete a lower parts kit and justifiably plan to build a complete rifle out of principle. Here is where you find everything needed to kit up your lower's stock assembly, finish the build and add it to the collection.



## JUMP TO A SERIES

	<b>AK SIDE FOLDER</b> <b>[NEW]</b>	<b>136</b>
	<b>AR COLLAPSIBLE STOCKS</b>	<b>138</b>
	S1 6-Position Stocks & Assemblies	
	S2 6-Position Stocks & Assemblies	
	S3 6-Position Stocks & Assemblies	
	S4 4-Position Stocks & Assemblies	
	U6 6-Position Stock Assemblies	
	<b>AR15 FIXED STOCKS</b>	<b>140</b>
	<b>AR308 FIXED STOCK</b>	<b>140</b>
	<b>TUBES &amp; BUFFERS</b>	<b>142</b>

(THIRD PARTY TRADEMARKS MAY BE USED IN THIS CATALOG FOR USER CONVENIENCE TO INDICATE THE FIT OR COMPATIBILITY OF THE APPLICABLE PRODUCT.)



# AK SIDE FOLDER

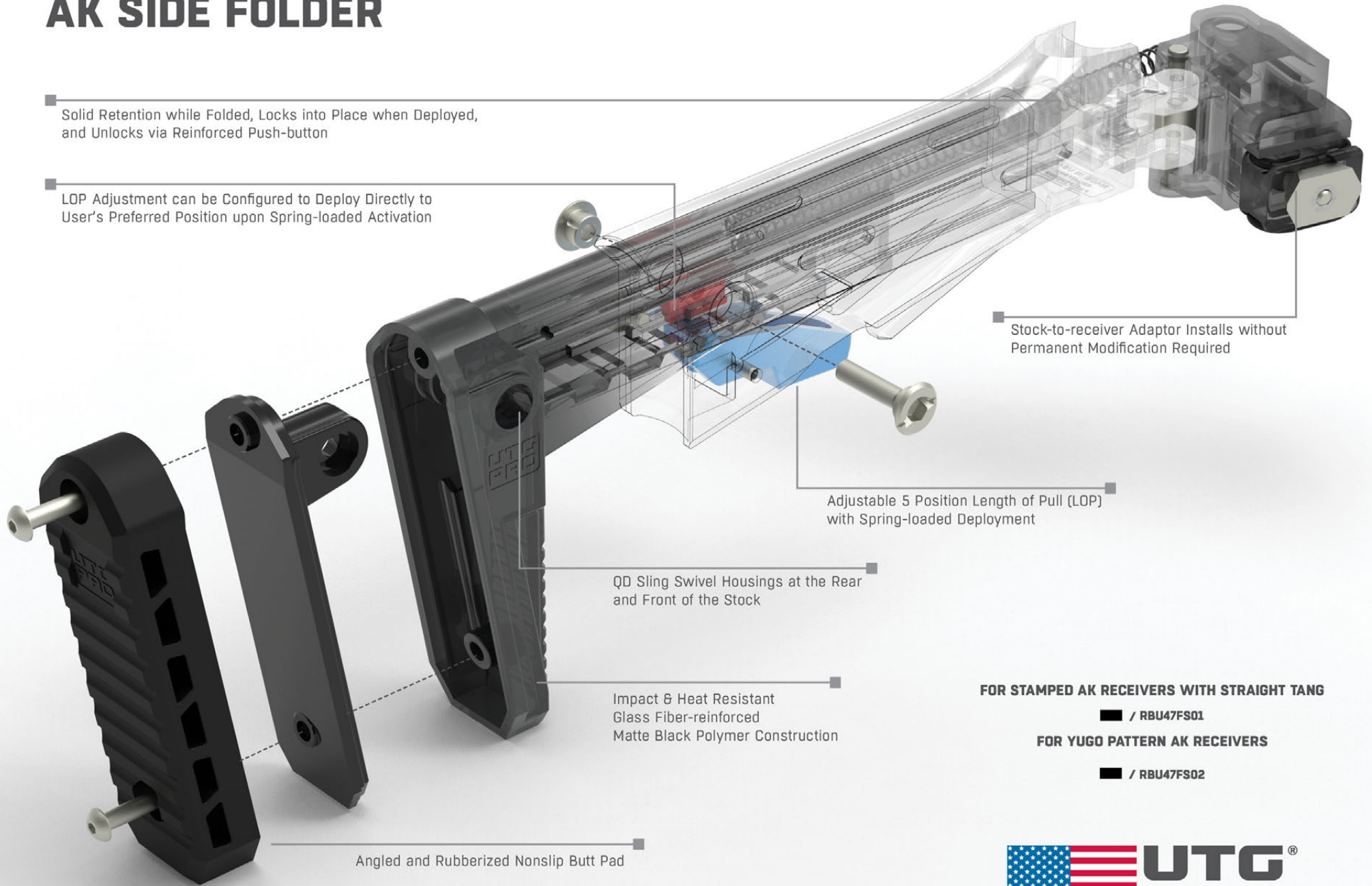

Solid Retention while Folded, Locks into Place when Deployed, and Unlocks via Reinforced Push-button

LOP Adjustment can be Configured to Deploy Directly to User's Preferred Position upon Spring-loaded Activation

Stock-to-receiver Adaptor Installs without Permanent Modification Required

Adjustable 5 Position Length of Pull (LOP) with Spring-loaded Deployment

QD Sling Swivel Housings at the Rear and Front of the Stock

Impact & Heat Resistant Glass Fiber-reinforced Matte Black Polymer Construction

Angled and Rubberized Nonslip Butt Pad

**FOR STAMPED AK RECEIVERS WITH STRAIGHT TANG**

■ / RBU47FS01

**FOR YUGO PATTERN AK RECEIVERS**

■ / RBU47FS02





Right-side Folding



Adjustable 5 Position Length of Pull (LOP)



Spring-loaded Deployment



Angled and Rubberized Nonslip Butt Pad

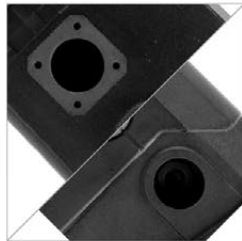

QD Sling Swivel Housings at the Rear and Front of the Stock



Reinforced Push-button Lockup



TOP VIEW

**UTG PRO**  **NEW**  
**AK SIDE FOLDER**

- » Proudly Designed and Made in USA
- » Impact & Heat Resistant Glass Fiber-reinforced Matte Black Polymer Construction
- » Folds to the Right for Compatibility with Side-mounted Optics
- » Solid Retention while Folded, Locks into Place when Deployed, and Unlocks via Reinforced Push-button
- » Adjustable 5 Position Length of Pull (LOP) with Spring-loaded Deployment
- » LOP Adjustment can be Configured to Deploy Directly to User's Preferred Position upon Spring-loaded Activation
- » Stock-to-receiver Adaptor Installs without Permanent Modification Required
- » Angled and Rubberized Nonslip Butt Pad
- » QD Sling Swivel Housings at the Rear and Front of the Stock
- » Counts as One US Part for 922R Compliance
- » US PAT. 11067360, US PAT. 11592264, US PAT. 11598604

Black 	<b>RBU47FS01</b>	<b>RBU47FS02</b>
Platform	Stamped AK with Straight Tang	Yugo Pattern AK
LOP Adjustment Range	2.84"	2.84"
LOP Adjustment Increment	5 Position ( 0.71"/Position)	5 Position ( 0.71"/Position)
LOP Collapsed	13.59"	13.59"
LOP Extended	16.42"	16.42"
Material	Polymer	Polymer
Dimensions	10.62" x 1.95" x 5.43"	10.62" x 1.95" x 5.43"
Weight	19.65 oz	19.65 oz

S-SERIES

 **UTG**  
**PRO**

# COLLAPSIBLE STOCKS



### S1 MIL-SPEC 6 POSITION STOCKS & ASSEMBLIES

- » Extended 8" Length for Increased Length of Pull

-  / Stock Assembly / RBUS1BM
-  / Stock Assembly / RBUS1DM
-  / Stock Only / RBUS1BMS
-  / Stock Only / RBUS1DMS



### S2 MIL-SPEC 6 POSITION STOCKS & ASSEMBLIES

- » Lightweight Slim Profile with Extended 7.50" Length for Increased Length of Pull

-  / Stock Assembly / RBUS2BM
-  / Stock Assembly / RBUS2DM
-  / Stock Only / RBUS2BMS
-  / Stock Only / RBUS2DMS



### S3 MIL-SPEC 6 POSITION STOCKS & ASSEMBLIES

- » Sub-compact Profile for Lightweight, Comfortable Performance
- » US PAT. D773005

-  / Stock Assembly / RBUS3BM
-  / Stock Assembly / RBUS3DM
-  / Stock Only / RBUS3BMS
-  / Stock Only / RBUS3DMS



### S4 MIL-SPEC 4 POSITION STOCKS & ASSEMBLIES

- » Lightweight, Ultra Sub-compact Profile, Ideal for SBR/SBS Applications
- » Included Removable Cheek Rest for Improved Shooting Stability and Comfort
- » US PAT. D818074

-  / Stock Assembly / RBUS4BM
-  / Stock Assembly / RBUS4DM
-  / Stock Only / RBUS4BMS
-  / Stock Only / RBUS4DMS



### U6 MIL-SPEC 6 POSITION STOCK ASSEMBLIES

- » Dual Standard Sling Loop Attachment Points
- » Lightweight Design with a Classic Look and Feel

-  / Stock Assembly / RBU6BM
-  / Stock Assembly / RBU6DM



## COLLAPSIBLE STOCKS

- » Proudly Designed and Made in USA
- » Stock Molded from Impact Resistant High Strength Polymer
- » Built for Heavy Duty Use with the Tightest Tolerance Controls to Provide the Most Secure Fit and Function

Black 	RBUS1BM	RBUS1BMS	RBUS2BM	RBUS2BMS	RBUS3BM	RBUS3BMS	RBUS4BM	RBUS4BMS	RBU6BM
FDE 	RBUS1DM	RBUS1DMS	RBUS2DM	RBUS2DMS	RBUS3DM	RBUS3DMS	RBUS4DM	RBUS4DMS	RBU6DM
Type	Mil-spec	Mil-spec	Mil-spec	Mil-spec	Mil-spec	Mil-spec	Mil-spec	Mil-spec	Mil-spec
	Stock Assembly	Stock Only	Stock Assembly	Stock Only	Stock Assembly	Stock Only	Stock Assembly	Stock Only	Stock Assembly
Dimensions	8.5" x 2.3" x 5.5"		8.0" x 1.5" x 5.3"		6.1" x 1.5" x 4.8"		4.3" x 1.7" x 4.8"		6.9" x 1.7" x 5.2"
Weight	23.1 oz	12.6 oz	19.7 oz	9.9 oz	16.9 oz	7.0 oz	15.5 oz	5.7 oz	16.9 oz



# FIXED STOCKS



Cheek Riser Included



Storage Compartment

## UTG PRO

### S5 FIXED STOCK

- » Proudly Designed and Made in USA
- » Stock Molded from Impact Resistant High Strength Matte Black Polymer
- » Built for Heavy Duty Use with the Tightest Tolerance Controls to Provide the Most Secure Fit and Function
- » Compatible with Rifle-length Receiver Extension Tube, Does Not Require A2 Buttstock Spacer
- » 11" Overall Length with Ergonomic Slanted Cheek Rest and Steel Reinforced Rubberized Butt Pad
- » Integral Picatinny Rail Attaches Included 0.23" Cheek Riser and Other Accessories
- » Reversible Quick Detach Sling Swivel Housing for Left or Right Handed Shooters and Standard Sling Swivel Stud for Traditional Slings

 / AR / Stock Only / RBUS5BMS-A

### A2 FIXED STOCK ASSEMBLIES

- » Stock Molded from Impact Resistant High Strength Polymer
- » (RB-T308FB) Compatible with ARMALITE® AR-10®, DPMS® LR-308, S&W M&P® 10, and Other Clones

 / AR15 / Stock Assembly / RB-T469B  
 / AR308 / Stock Assembly / RB-T308FB

Black 	RBUS5BMS-A	RB-T469B	RB-T308FB
Platform	AR	AR15	AR308
	Stock Only	Stock Assembly	Stock Assembly
Dimensions	10.5" x 2.0" x 5.6"	10.8" x 1.6" x 5.1"	10.8" x 1.6" x 5.1"
Weight	14.8 oz	26.4 oz	25.5 oz





# TUBES & BUFFERS



**UTG PRO** 

## MIL-SPEC 6 POSITION RECEIVER EXTENSION TUBES & KITS

- » Extension Tube CNC Machined from 7075-T6 or 6061-T6 Aircraft Aluminum with Precisely Rolled Threads for Durable Thread Engagement with Lower Receiver
- » Tightest Tolerance Controls for a Secure Fit and Function with Various Collapsible Stocks
- » Finished in a Matte Black/Blue/Red/Bronze Hard Coat Anodization or FDE CERAKOTE®

-  / Tube Only / TLU001
-  / Tube Only / TLU001R
-  / Tube Only / TLU001B
-  / Tube Only / TLU001D 
-  / Tube Only / TLU001Z
-  / Tube Only / 7075-T6 / TLU001MS
-  / Tube Kit / TLU001-KIT
-  / Tube Kit / TLU001D-KIT 



**UTG PRO** 

## AR308 6 POSITION RECEIVER EXTENSION TUBE

- » 6-position Mil-spec Diameter Receiver Extension Tube for AR308 Rifles
- » Extension Tube CNC Machined from 6061-T6 Aircraft Grade Aluminum with Precisely Rolled Threads for Durable Thread Engagement with Lower Receiver
- » Tightest Tolerance Controls for a Secure Fit and Function with Various Collapsible Stocks
- » Finished in a Matte Black Type III Class II Hard Coat Anodized Finish

-  / Tube Only / TLU002



## CARBINE-LENGTH RECOIL BUFFERS

- » Potentially Increases Dwell Time, Eases Extraction, and Reduces Felt Recoil



- H2 / 4.6 oz / RB-T6BFH2
- H3 / 5.4 oz / RB-T6BFH3



**UTG PRO** 

## AR PISTOL RECEIVER EXTENSION TUBE & KIT

- » 1.2" OD Receiver Extension Tube Compatible with AR15 Lower Receivers
- » Precision Machined from 7075-T6 Aircraft Aluminum with a Dry Film Lube Coated Interior for Smoother and More Reliable Cycling
- » Finished in a Matte Black Type III Class II Hard Coat Anodized Finish
- » Compatible with Standard AR15 Type Buffers and Springs
- » Compatible with Most AR Pistol Receiver Extension Tube Covers



-  / Tube Only / 7075-T6 / TLU008
-  / Tube Kit / 7075-T6 / TLU008-KIT



**UTG PRO** 

## AR PISTOL EXTENDED RECEIVER EXTENSION TUBE & KIT

- » Precision Machined from 7075-T6 Aircraft Aluminum with a Dry Film Lube Coated Interior for Smoother and More Reliable Cycling
- » Finished in a Matte Black Type III Class II Hard Coat Anodized Finish
- » Compatible with Standard AR15 Type Buffers and Springs
- » 8.5" Extended Length and Compatible with GEAR HEAD WORKS® TAILHOOK™ MOD 1/1C Brace and or Most AR Pistol Receiver Extension Tube Covers

-  / Tube Only / 7075-T6 / TLU009
-  / Tube Kit / 7075-T6 / TLU009-KIT



## A2 RECEIVER EXTENSION TUBE KIT

- » Rifle-length Extension Tube Precision Machined from 6061-T6 Aluminum and Finished in a Matte Black Anodization
- » Includes Rifle-length Extension Tube, Buffer, and Spring, A2 Stock Spacer, and Stock Screw

-  / Tube Kit / TLT-A2KT